

2023

PRODUCT CATALOG

Sample Separation

Sample Concentration

Sample Growing

Sample Storage

hanil

More than 60 years of Quality and Trust

Since 1958, Hanil Scientific Inc. has been keeping its core technology of making trust worthy centrifuges for all laboratories and medical uses. Major parts of Hanil Scientific centrifuges, including induction motors, rotors, and chassis are all manufactured and fabricated in-house and go through strict quality assurance processes. The ISO9001, ISO13485, and KGMP certified factory is equipped with the latest computerized tools and large-format CNC machines to provide a continuum of support for physical production for the models that demand the highest precision in the toughest condition. Along the latest tools added with proud Korean craftsmanship, Hanil strives to produce top-quality products with intuitive controls to provide the best laboratory systems for your setting.

hanil



Sample Separation

Centrifuge Overview - p.7

Rotor Selection Guide - p.10

Catalog Numbering Rule - P.13

Micro Centrifuges - p.14

Multi-purpose Centrifuges - p.17

Super Speed (High Speed) Centrifuges - p.32

Large Capacity Centrifuges - p.44

Clinical Centrifuges - p.49

Accessories - p.60

Industrial Centrifuges - p.68



Sample Concentration

Centrifugal Vacuum Concentrators - p.74

Freeze Dryers & Cooling Traps - p.82

Gas Purging Evaporation Concentrator - p.88



Sample Growing

Laboratory Fermentors - p.94

Photo Bioreactors - p.98

CO2 Incubator - p.100

Sample Storage

Deep Freezers - p.106

Accessories - p.111

Sample Separation

Centrifuge Overview - p.7

Rotor Selection Guide - p.10

Catalog Numbering Rule - P.13

Micro Centrifuges

Mini6 / Mini6-RC / M13 - P.14

M15 / M15R - P.15

Multi-purpose Centrifuges

T04B / T05R - P.17

Combi 508 - P.24 / Combi R515 - P.25

Super speed (High Speed) Centrifuges

Supra R12 - P.32 / Supra R17 - P.33 / Supra R22 - P.34

Supra R30 - P.35 / Ultra 5.0 - P.41

Large Capacity Centrifuges

Component wR / Component R6 / Component R12 - P.44

Clinical Centrifuges

T04 - p.50 / Fleta 4 - P.51 / CellSpin II - P.54

SeroSpin -P.56 / HematoSpin - P.58

Accessories

Tube Racks (Adaptors) - p.60

Industrial Centrifuges

J1250 - P.68

HA400 - P.71

Laboratory Centrifuge's Structure and Selection Criteria

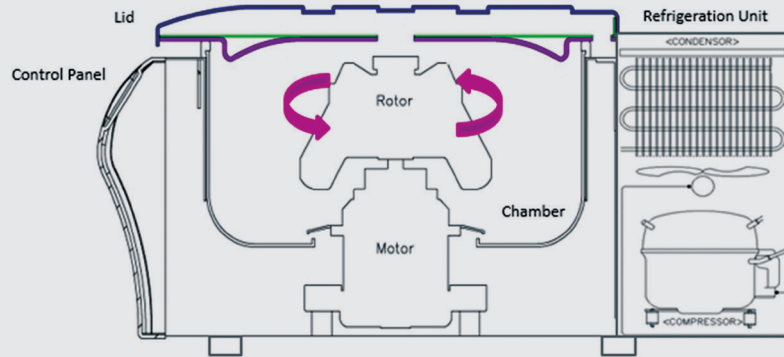

Purpose of Centrifugation

Precipitation, phase separation or density gradient

Depending on the goal of the centrifugation, proper rotor should be selected concurrently with the g-force to be applied into the sample.

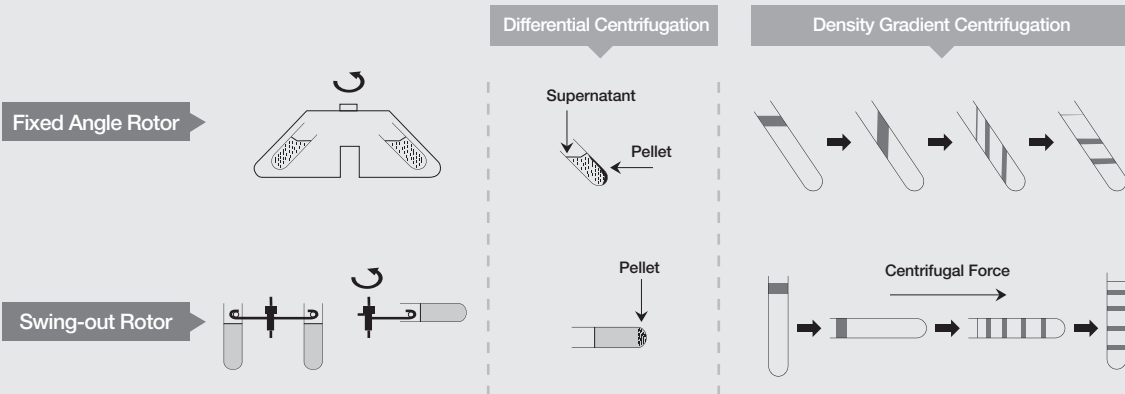

Max g-force to achieve complete separation

Not only the speed (RPM : Revolution Per Minute) of a centrifuge but also the RCF (Relative Centrifugal Force) of a rotor should be checked for the best result of centrifugation.

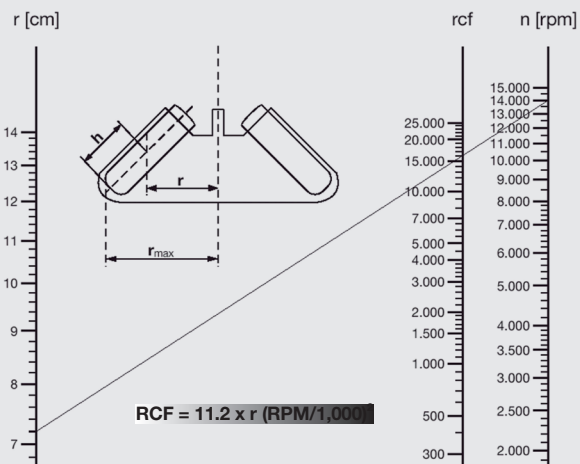

Temperature Control Method

According to the characteristic of a sample to be centrifuged, compressor cooled, passive refrigeration model or air-flow controlled model can be selected. When the samples are sensitive to over-ambient or fluctuating temperature, a refrigeration model is highly recommended.

Selection Guide of Hanil Centrifuges

Group		Micro				Multi-purpose, Table top				Super speed					Large Capacity		
Model		p.14	p.14	p.15	p.15	p.17	p.17	p.24	p.25	p.32	p.33	p.34	p.35	p.41	p.44	p.44	p.44
Max.	Fixed Angle	6,500	13,500	15,000	15,000	4,000	5,000	8,000	15,000	12,000	17,000	22,000	30,000	50,000			
	Swing-out					4,000	5,000	4,000	4,500						4,500	5,000	4,500
Refrigeration		-	-	-	❄️	-	❄️	-	❄️	❄️	❄️	❄️	❄️	❄️	❄️	❄️	❄️
Vacuum		-	-	-	-	-	-	-	-	-	-	-	⦿	⦿	-	-	-
Choices by Max. g-force (RCF, xg)																	
Fixed Angle Rotor	250,000 xg																254,300
	100,000 xg																
	50,000 xg																
	30,000 xg																
	25,000 xg				21500	21500											
	10,000 xg		12,000					8,200	25,300	22,200	31,000	52,000	99,500				
	5,000 xg	2,200				2,700	4,200										
	0																
Swing-out Rotor	7,500 xg																
	6,000 xg																
	5,000 xg														5,000	7,200	6,400
	3,500 xg								4,300								
	2,000 xg					2,700	3,900	3,500									
	0																
Choices by Sample Container																	
Micro Plates																	S
Micro Tubes	PCR Strip	F	F	F	F												
	0.2/0.5 mL	F	F					F	F		F						
	1.5/2.0 mL	F	F			S	S	F	F		F						
	Micro filter tube																
Tubes	5 mL		F	F	F												
	3 / 4 / 5 mL					F/S	F/S	S	S								S
	10 / 15 mL					F/S	F/S	F/S	F/S		F	F	F	F			S
	15 mL conical					F/S	F/S	F/S	F/S		F	F	F				S
	25 mL					F/S	F/S										
	30 mL					F/S	F/S	F	F		F	F	F				
	38.5 mL													F			
	50 mL conical					F/S	F/S	F/S	F/S		F	F	F				S
	50 mL Skirt					F/S	F/S										
	50 mL					F/S	F/S	F/S	F/S		F	F	F	F			S
	85 mL					S	S	F/S	F		F	F	F				
	100 mL					S	S							F			
	250 mL							S	F/S	F	F	F	F	F			S
	250 mL conical							S	S								S
	500 mL							S	S	F		F	F				S
	500 mL conical							S	S								
750 mL							S	S								S	
1,000 mL									F		F	F				S	
Blood Bags																S	S

* F stands for Fixed angle rotor and S for Swing-out rotor.

Features of Hanil Scientific's Laboratory Centrifuges

Premium Quality

- Accurate speed control less than 1.0% variance by high performance microprocessor
- high torque AC induction motor and reliable sensors
- Accurate temperature control by IC sensor and temperature offset function
- Unique motor drive system optimized in each rotation space
- Flexible or soft spindle drive system resulting in "self balancing" gyro moment for high speed models
- PABS (Positive Action Brake System) for stable and fast deceleration
- Dual ramp deceleration profile for keeping centrifuged samples at the best result
- Vacuum and sealing techniques to minimize air friction at super speed rotation
- Unique air flow structure for effective noise reduction and excellent cooling
- Unique anti-vibration damping structure for gentle operation
- Patented compressor damping structure to reduce vibration and maintain efficient separation
- Very finely fabricated motors, rotors, buckets, and accessories by Korean craftsmanship
- Very smooth tube insertion and removal through the precisely carved holes of rotors and buckets
- Bio-safe rotors and buckets allow to handle any sample in safety
- Accredited with ISO9001, ISO13485, and KGMP
- Comply with CE conformity
- KFDA registered or certified as medical device

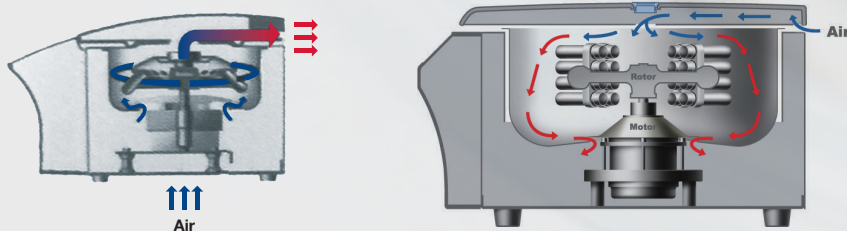

Superior Safety

- Durable chassis with steel armored chamber and steel layered lid
- Automatic interlock system to prevent rotor's spinning when lid is open
- Lid drop protected construction and fine control of lid opening
- Detection or alarm to sense imbalance, lid open, overspeed, low speed or over-heating
- Mounted with imbalance detection and tracking devices using by Hall sensor or limit switch
- Adjustable imbalance cutoff and tracking function
- Password enabled lock and unlock function in some models
- Automated rotor recognition system for the protection of over speed and improper operation
- User friendly emergency opening when black-out happens to retrieve sample safely
- Easy to clean surface and parts, and autoclavable rotors and buckets for contamination free maintenance
- Maintenance-free, less heat-generating, noiseless AC induction motor

Greatest Convenience

- Single action of rotor coupling and decoupling only by rotor lid closure or opening (no need of any tool) for large sizes of Fixed Angle Rotors
- New "Easy-Lock" rotor allows fast and convenient lid locking. (Micro fixed angle rotors only)
- Self-lock rotor coupling, triggered by centrifugal force while spinning (Ultra model)
- Ergonomically arranged control and display
- Intuitive control panel and easy to read comprehensive displays with LED lights
- Automated rotor recognition scheme with automatic g-force calculation and display
- Automatic last run call and convenience to call, modify, or save data
- Stress-free lid opening and closure by smoothly motorized lid lock structure
- Effortlessly working manual lid opening scheme to take sample out safely
- Easy to clean drainage from the chamber hole of refrigerated models

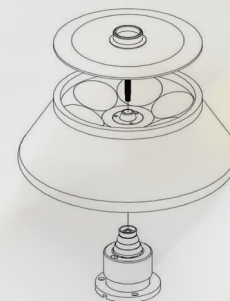

Single action of rotor coupling
-Large volume Fixed Angle Rotor

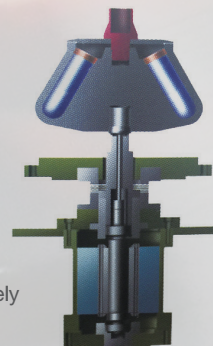

Jut (rotating)

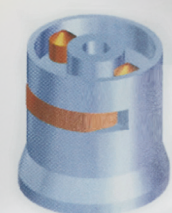









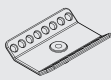
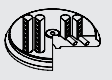





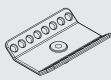
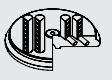



Flat (stop)

Self-lock-rotor coupling of Ultra 5.0

















Selection Guide of Fixed Angle Rotor

* Radius is the distance from the center of the rotor to the inner end of tube carrier in mm.







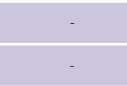
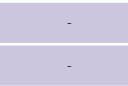
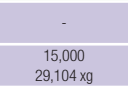
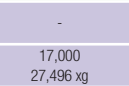
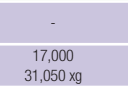
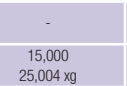
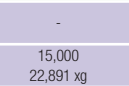
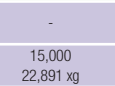
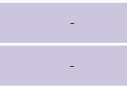
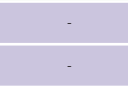
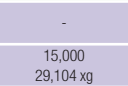
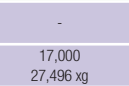
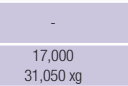
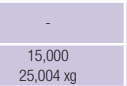
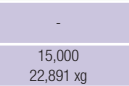
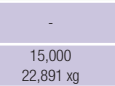

Micro Centrifuges									
Rotor Shape									
Cat. No.		A0.2-16	A0.2-32	AEB*-0.2-32	A2.0-6	A2.0-12	AEB*-2.0-24	A5.0-6	AE-5.0c-10
Rotor ID		-	-	2	-	-	1	-	3
Max. Capacity		16 x 0.2 mL	32 x 0.2 mL	32 x 0.2 mL	6 x 1.5/2.0 mL	12 x 1.5/2.0 mL	24 x 1.5/2.0 mL	6 x 5.0 mL	10 x 5.0 mL conical
Hole dimension (Ø x L,mm)		6.5 x 3	6.5 x 15	6.5 x 16	11.1 x 3	11.1 x 38	11.1 x 39	16.8 x 29	17 x 53
Radius(mm)		29.9	Inner line : 44.06 Outer line : 55.68	56.4	47.3	59	84.3	65	85.8
Max. height for tube fit(mm)		15	-	25	39	48	52	60	68
M6	Max. RPM Max. RCF	6,500 1,412 xg	-	-	6,500 2,234xg	-	-	-	-
M13		-	6000 Inner line : 1,773 xg Outer line : 2,241 xg	-	-	13,500 12,032xg	-	6,000 2,612xg	-
M15/M15R		-	-	12,500 9,852xg	-	-	15,000 21,206xg	-	15,000 21,583xg

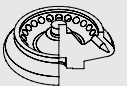
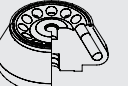
Multi-Purpose Centrifuges				
Rotor Shape				
Cat. No.		A0/A**-15-24	A0/A**-50c-10	A0/A**-50-10
Rotor ID		5	3	2
Max. Capacity		24 x 15 mL	10 x 50 mL Conical	10 x 50 mL
Hole dimension (Ø x L,mm)		20.4 x 10	32.2 X 13.5	32.2 X 13.5
Radius(mm)		155	140	142.5
Max. height for tube fit(mm)		125	130	130
T04B	Max. RPM Max. RCF	4,000 2,773 xg	4,000 2,508 xg	4,000 2,549 xg
T05R		4,500 3,509 xg	5,000 3,913 xg	5,000 3,983 xg

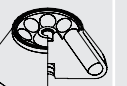
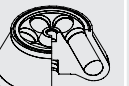
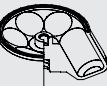
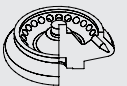
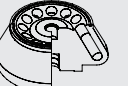

**Bio-Safe Rotor
**A0 is for T04B
A is for T05R

Multi-Purpose Centrifuges									
Rotor Shape									
Cat. No.		A0.2-48	A2.0-24	A2.0-36	A10-12	A15S-12	A15c-12	A50-6	A50c-6
Rotor ID		18	1	14	2	4	8	5	6
Max. Capacity		48 x 0.2 mL	24 x 1.5/2.0 mL	36 x 1.5/2.0 mL	12 x 10 mL	12 x 15 mL	12 x 15 mL conical	6 x 50 mL	6 x 50 mL conical
Hole dimension (Ø x L,mm)		6.5 x 17	11 x 37.5	11 x 37.5	16.3 x 74.5	19 x 96	17.2 x 110	29.5 x 100	29.8 x 108.6
Radius(mm)		88.9	80.8	115.7	85.1	96.1	99.4	96.1	91
Max. height for tube fit(mm)		-	46	49	85.5	109.5	123.2	122.7	118.1
Combi 508	Max. RPM Max. RCF	8,000 6,351 xg	8,000 5,781 xg	8,000 8,279 xg	8,000 6,089 xg	8,000 6,876 xg	8,000 7,112 xg	8,000 6,876 xg	8,000 6,511 xg
Combi R515		12,500 15,530 xg	15,000 20,325 xg	14,000 25,353 xg	15,000 21,407 xg	15,000 24,174 xg	15,000 25,004 xg	15,000 24,174 xg	15,000 22,891 xg

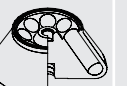
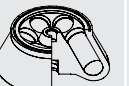
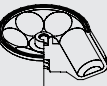
Super Speed Centrifuge									
Rotor Shape									
Cat. No.		Supra R12	Supra R17	Supra R22	Supra R30	Supra R12	Supra R17	Supra R22	Supra R30
Rotor ID		-	-	-	-	-	-	-	-
Max. RPM Max. RCF		-	-	-	-	-	-	-	-
Max. RPM Max. RCF		-	15,000 29,104 xg	18,000 41,910 xg	20,000 51,741 xg	17,000 27,496 xg	17,000 31,050 xg	15,000 25,004 xg	15,000 22,891 xg
Max. RPM Max. RCF		-	-	22,000 46,049 xg	30,000 85,628 xg	22,000 46,049 xg	22,000 52,001 xg	17,000 32,116 xg	17,000 29,402 xg

Super Speed Centrifuge									
Rotor Shape									
Cat. No.		A2.0U-24	A10U-12	A13.5U-8	A13.5U-12	A38.5U-6	A50U-8	A94U-6	A250U-6
Rotor ID		3	4	5	1	9	6	7	8
Max. Capacity		24 x 1.5/2.0 mL	12 x 10 mL	8 x 13.5 mL	12 x 13.5 mL	6 x 38.5 mL	8 x 50 mL	6 x 94 mL	6 x 250 mL
Hole dimension (Ø x L,mm)		11 x 37.5	16.3 x 70	16.3 x 83	16.3 x 83	25.6 x 92	29 x 100.5	38.5 x 105	60 x 101
Radius(mm)		82	80.3	73	87	91	98	99.4	129
Max. height for tube fit		47.1	71.5	84.4	83.4	98.9	107.3	110.7	126.9
Ultra 5.0	Max. RPM Max. RCF	40,000 146,680 xg	45,000 181,795 xg	50,000 204,035 xg	50,000 243,160 xg	50,000 254,340 xg	30,000 98,784 xg	35,000 136,377 xg	20,000 57,792 xg

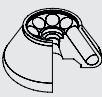

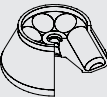
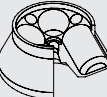
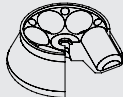
					
A50-8	A85-6	A250-6	A500-6	A1000-4	A1000-6
7	9	10	11	12	13
8 x 50 mL	6 x 85 mL	6 x 250 mL	6 x 500 mL	4 x 1000 mL	6 x 1000 mL
29.5 x 100	38.5 x 95	62 x 103	70 x 141	98 x 144	98 x 144
98.9	97.6	138.3	158.7	169.9	200.1
110.7	115.4	132	168.5	184.8	176.5
8,000	8,000	-	-	-	-
7,076 xg	6,983 xg	-	-	-	-
15,000	15,000	8,000	-	-	-
24,878 xg	24,551 xg	9,896 xg	-	-	-
-	-	12,000	10,000	8,000	7,000
-	-	22,265 xg	17,743 xg	12,157 xg	10,962 xg
15,000	15,000	10,000	-	-	-
24,878 xg	24,551 xg	15,462 xg	-	-	-
20,000	20,000	12,000	9,000	8,000	-
44,228 xg	43,647 xg	22,265 xg	14,372 xg	12,157 xg	-
30,000	25,000	10,000	8,000	7,000	-
99,513 xg	68,198 xg	15,462 xg	11,355 xg	9,307 xg	-

Selection Guide of Swing-out Rotor

* Radius is the distance from the center of the rotor to the inner end of tube carrier in mm.

Multi-Purpose Centrifuges		Rotor Shape		Rotor Shape		Rotor Shape		Rotor Shape		
		S0/S**-15-6*(0) T04B		S0/S**-50-4		S0/S**-100-4		S0/S**-mw-2		
Rotor Shape										
Cat. No.		S0/S**-15-6*(0) T04B		S0/S**-50-4		S0/S**-100-4		S0/S**-mw-2		
Bucket Cat.No.										
Rotor ID		6	1			4			7	
Max.Capacity		4x2x15mL	4x50mL	4x50mL conical	4x2x15mL conical	4x100mL	4x2x50mL conical	4x2x15mL conical	4x8x15mL	2x4 MTPs
Hole dimension (Ø x L,mm)		17 x 88	30.5 x 91	29.5 x 91.5	17 x 91.5	47 x 99	30x89	17 x 97.5	17 x 86	86.5 x 128.5
Radius(mm)		153	150.9	150.9	150.9	155.1	155.1	155.1	152	60
Max. height for tube fit(mm)		122	125	125	120	130(w/o cap)/120(w/ cap)	125	125 (w/o cap)/120 (w/ cap)	115	111.8
T04B	Max. RPM	4,000	4,000	4,000	4,000	4,000	4,000	4,000	4,000	4,000
	Max. RCF	2,737	2,700	2,700	2,700	2,774	2,774	2,774	2,719	2,000
T05R	Max. RPM	4,400	5,000	5,000	5,000	4,500	4,500	4,500	4,500	4,000
	Max. RCF	3,312	4,218	4,218	4,218	3,511	3,511	3,511	3,441	2,000
Rotor Shape										
		S500-4		S750-4						
Cat. No.		S500-4		S750-4						
Rotor ID		12		13						
Bucket Cat.No.										
Max.Capacity		4x500mL	4 MTPs/DWPs	4x750mL	4 MTPs/DWPs					
Radius(mm)		194	154	196.5	163.5					
Max. height for tube fit		154(w/o cap) 144(w/cap)	55	158.5(w/o cap) 142(w/cap)	60					
Combi 508	Max. RPM	4,000		4,000	4,000					
	Max. RCF	3,470		2,755	2,925					
Combi R515	Max. RPM	4,500								
	Max. RCF	4,392								
Rotor Shape										
		WS750-6		WS1000-6		WS2400-6				
Cat. No.		WS750-6		WS1000-6		WS2400-6				
Bucket Cat.No.										
Max.Capacity		6x750mL	6 MTPs/DWPs	6x1000mL	6x2x500mL Blood bag					
Radius(mm)		225	191.9	259.8	286.7					
Max. height for tube fit(mm)		157.5(w/o cap) 128(w/cap)	60	188.5(w/o cap) 169(w/cap)	209.2					
Component wR	Max. RPM	4,500	4,500	-	-					
	Max. RCF	5,096	4,345	-	-					
Component R6	Max. RPM	-	-	5,000	-					
	Max. RCF	-	-	7,261	-					
Component R12	Max. RPM	-	-	-	4,500					
	Max. RCF	-	-	-	6,491					

Large Clinical Centrifuges		Rotor Shape		Rotor Shape		Rotor Shape	
		WS750-6		WS1000-6		WS2400-6	
Rotor Shape							
Cat. No.		WS750-6		WS1000-6		WS2400-6	
Bucket Cat.No.							
Max.Capacity		6x750mL	6 MTPs/DWPs	6x1000mL	6x2x500mL Blood bag		
Radius(mm)		225	191.9	259.8	286.7		
Max. height for tube fit(mm)		157.5(w/o cap) 128(w/cap)	60	188.5(w/o cap) 169(w/cap)	209.2		
Component wR	Max. RPM	4,500	4,500	-	-		
	Max. RCF	5,096	4,345	-	-		
Component R6	Max. RPM	-	-	5,000	-		
	Max. RCF	-	-	7,261	-		
Component R12	Max. RPM	-	-	-	4,500		
	Max. RCF	-	-	-	6,491		

Catalog Numbering Rule of Centrifuge and Accessories

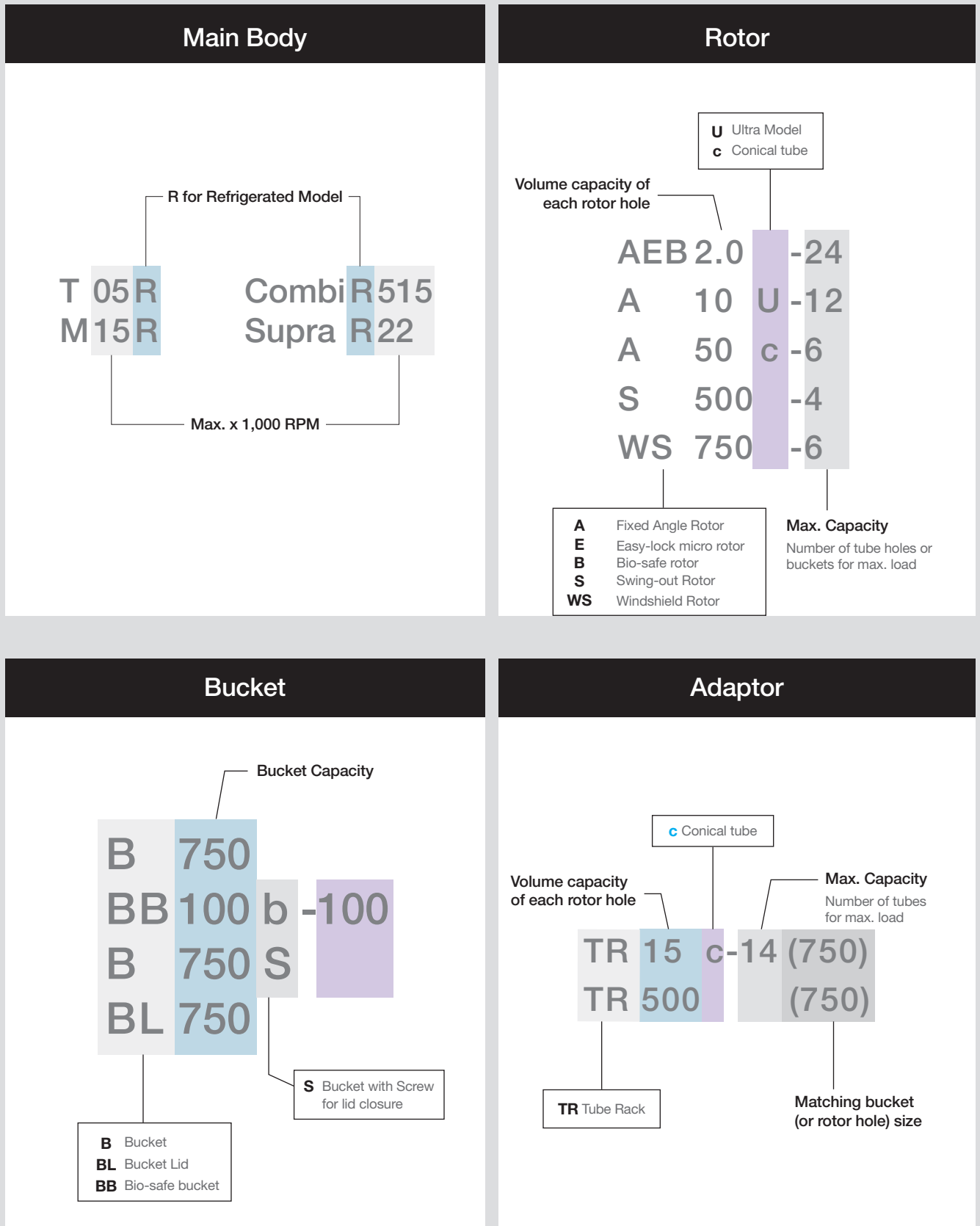

There may be exceptions to the rule. For more information, refer to the specific pages of model.

Micro Centrifuges

Mini 6 / Mini 6-RC / M13 / M15 / M15R

Micro Centrifuges

Mini 6 / Mini 6-RC

- Quick spin action simply by closing the lid and safety stop by opening the lid
- Selectable operation modes short spin or continuous 15 minutes
- Interchangeable rotors for 6 micro tubes and 2 PCR strips
- Electro sensitive contacting lid sensor
- Optional cordless model, Mini 6-RC(Rechargeable Lithium battery)



M13

- Ideal for simple and efficient spinning at high speed
- Accommodate sample tubes from PCR strip to 5 ml
- Very quiet operation even at max speed of 13,500 rpm
- Deceleration within 8 sec from max speed
- Simplified operation with rotating knobs for rpm and time
- Available with 3 interchangeable rotors
- Safety features ensure it will not spin when the lid is open.
- Well-designed, non-slip silicone rubber feet



A2.0-12



A0.2-32

Technical Specifications

		Mini6 / Mini6-RC	M13	M15 / M15-md*	M15R / M15R-md*
Speed RCF (xg)	Max. RPM (Fixed angle)	6,500 rpm	13,500 rpm	15,000 rpm	15,000 rpm
	Max. RCF (Fixed angle)	2,234 xg	12,032 xg	21,583 xg	21,583 xg
Max. capacity (Fixed angle)		6 x 1.5 / 2.0 mL, 2 x (8-Tube or PCR Strip)	6 x 5.0 mL 12 x 1.5 / 2.0 mL 4 PCR strips	10 X 5.0 mL, 24 x 1.5 / 2.0 mL, 4 PCR strips	10 X 5.0 mL, 24 x 1.5 / 2.0 mL, 4 PCR strips
ACC/DEC	ACC / DEC ramps			9 / 10 steps	9 / 10 steps
	ACC time to max speed	3 sec	≤18 sec	≤15 sec	≤15 sec
	DEC time from max speed	4 sec	≤8 sec	≤15 sec	≤15 sec
Temperature	Temperature range				-10°C to 40°C
	Fast cool	-	-	-	Yes
Time control		Selectable, Short Spin (10 sec) or Continuous (15 min)	≤15 min, pulse	< 100 min, pulse, continuous	< 100 min, pulse, continuous
Program memory		-	-	10	10
Noise level		-	< 60 dB	< 60 dB	< 60 dB
Imbalance cutoff		-	-	Yes	Yes
Dimension (W x D x H, mm)		150 x 150 x 90	189 x 202 x 129	293 x 380 x 242	285 x 593 x 281
Weight		650 g	1.5 kg	15 kg	33 kg
Power requirement		-	200 VA	500 VA	2.5 kVA
Power input (V,Hz)		AC 100~240 V 50/60 Hz (rechargeable Lithium- Battery(Mini6 - RC only)	210 V~240 V, 50/60 Hz (110 V optional)	210 V~240 V, 50/60 Hz (110 V optional)	210V~240 V, 50/60 Hz (110 V optional)
Cat. No.		Mini6	M13	M15 / M15-md	M15R / M15R-md

Micro Centrifuge

M15 / M15R

- Performance up to 15,000 RPM with 24 hole rotor
- Compact design and light-weight micro centrifuges
- Small footprint with outstanding features, suited for molecular biology works
- High quality anodized aluminum rotors and rotor lid
- Available with 3 interchangeable rotors
- New “Easy-Lock” rotor allows fast and convenient lid opening.
- Tightly sealed rotor with two V-shape rubber rings and an O-ring
- Ideal for very quiet and fast operation
- Easy to readable graphical LCD display
- Program up to 10 routine protocols
- Soft-touch lid closure with motorized lid mechanics for stress-free lid locking
- Easy-to-clean, UV resistant surface and stainless steel chamber



AEB-0.2-32



AEB-2.0-24



AE-5.0c-10



M15R











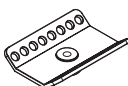

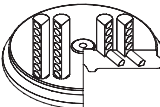

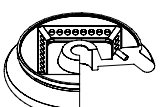







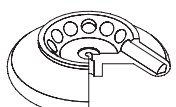





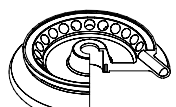

M15

Micro Centrifuges

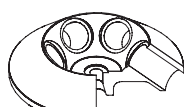
Mini 6 / Mini 6-RC / M13 / M15 / M15R

Fixed Angle Rotors for Micro Centrifuges

Rotor	Adaptable Centrifuge	Tube Capacity (Tube Size)	Required Adaptor	Bore Ø x L (mm) Radius (mm)	Max. RPM (rpm) Max. RCF (xg)			
A0.2-16  <p>Hole angle rotation : $\angle 45^\circ$ Max. Capacity : 16 x 0.2 mL Size (w x d x h) : 73.5 x 55.2 x 20.8mm</p>	Mini 6	 0.2 mL	-	6.5 x 3 29.9	6,500 1,412			
		 0.2 mL strips						
A0.2-32  <p>Hole angle : $\angle 45^\circ$ Max. Capacity : 32 x 0.2 mL Size (Ø x H) : Ø124 x 22 mm</p>	M13	 0.2 mL	-	6.5 x 15 Inner line : 31.13 (Min.) 44.06 (Max.) Outer line : 46.13 (Min.) 55.68 (Max.)	6,000 Inner line : 1,253~1,773 Outer line : 0.2 mL strips - 1,857~2,241			
		 0.2 mL strips						
AEB-0.2-32  <p>Hole angle : $\angle 45^\circ$ Max. Capacity : 32 x 0.2 mL Size (Ø x H) : Ø151.8 x 52 mm Max. height for tube fit (mm) : 25</p>	M15 M15R	 0.2 mL	-	6.5 x 16 56.4	12,500 9,852			
		 0.2 mL strips						
A2.0-6  <p>Hole angle : $\angle 45^\circ$ Max. Capacity : 6 x 1.5/2.0 mL Size (Ø x H) : Ø87.9 x 24.5 mm Max. height for tube fit (mm) : 39</p>	Mini 6	 1.5/2.0 mL	-	11.1 x 30 47.3	6,500 2,234			
		 0.5 mL				TR0.5(2) 	8 x 31 36.2	6,500 1,710
		 0.2 mL				TR0.2(2) 	6.5 x 23 29.2	6,500 1,379
A2.0-12  <p>Hole angle : $\angle 45^\circ$ Max. Capacity : 12 x 1.5/2.0 mL Size (Ø x H) : Ø124 x 37 mm Max. height for tube fit (mm) : 48</p>	M13	 1.5/2.0 mL	-	11.5 x 38 59	13,500 12,032			
		 0.5 mL				TR0.5(2) 	8 x 37 54	13,500 11,003
		 0.2 mL				TR0.2(2) 	6.3 x 21 44	13,500 8,965
AEB-2.0-24  <p>Hole angle : $\angle 45^\circ$ Max. Capacity : 12 x 1.5/2.0 mL Size (Ø x H) : Ø171.6 x 57 mm Max. height for tube fit (mm) : 52</p>	M15 M15R	 1.5/2.0 mL	-	11.1 x 39 84.3	15,000 21,206			
		 0.5 mL				TR0.5(2) 	8 x 31 73	15,000 18,363
		 0.2 mL				TR0.2(2) 	6.5 x 23 67	15,000 16,854
A5.0-6  <p>Hole angle : $\angle 50^\circ$ Max. Capacity : 6 x 5.0 mL Size (Ø x H) : Ø104 x 37.4 mm Max. height for tube fit (mm) : 60</p>	M13	 5 mL	-	16.8 x 29 65	6,000 2,612			
AE-5.0c-10  <p>Hole angle : $\angle 45^\circ$ Max. Capacity : 10 x 5.0 mL Size (Ø x H) : Ø176 x 60 mm Max. height for tube fit (mm) : 68</p>	M15 M15R	 5 mL	-	17 x 53 85.8	15,000 21,583			

* Radius : From the center of the rotor to the inner end of tube carrier.

Multi-purpose Centrifuge

T04B / T05R

- Multipurpose table-top centrifuge
- Usage of 10 x 50 mL conical tubes for fixed angle rotors and 8 x 50 mL conical tubes for swing-out rotors
- Process up to 32 vacutainer tubes
- Offers up to 7 optional rotors including 2 x 2 microplates
- Outstanding sample separations with 9 acceleration and 10 deceleration ramps
- Selectable time counting mode of “from starting” or “At set speed”
- Simplified operation with numeric key buttons
- Up to 100 different routine protocols can be stored in program memory and easily retrieved.
- Quiet performance promotes a safe and stress-free environment.
- Easy-to-clean stainless steel chamber and UV resistance exterior
- Outstanding safety and durability with two layers of steel lid
- Lid drop protection allows easiness and safety when loading or unloading samples.
- Low access height for easy loading and unloading of samples
- Selectable key lock function to prevent accidental parameter changes
- Fast cool function for fast pre-cooling (T05R only)

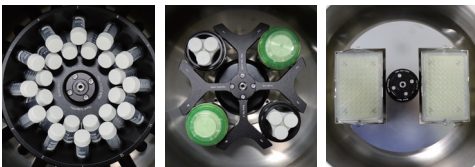

AO/A*-15-24 SO/S*-100-4 SO/S*-mw-2

**AO/SO are for T04B
A/S are for T05R



T04B



T05R











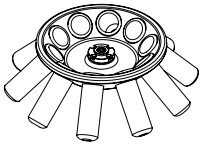











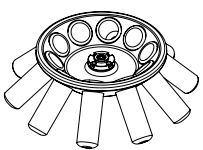

Micro Centrifuges

T04B / T05R / Combi 508 / Combi R515

Technical Specifications











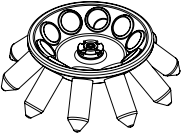









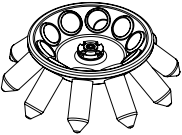









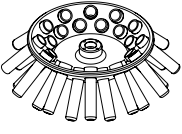







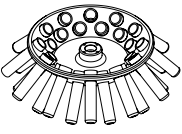

		T04B / T04B-md*	T05R / T05R-md*
Speed	Max. RPM (Fixed angle)	4,000 rpm	5,000 rpm
	Max. RCF (Fixed angle)	2,773 xg	3,983 xg
	Max. RPM (Swing-out)	4,000 rpm	5,000 rpm
	Max. RCF (Swing-out)	2,774 xg	4,218 xg
Max. capacity	Fixed angle	10 x 50 mL	10 x 50 mL
	Swing-out	4 x 100 mL	4 x 100 mL
ACC/DEC	ACC / DCC ramps	9 / 10 steps	9 / 10 steps
Temperature	Temperature range		-10 °C ~ 40 °C
	Fast cool	-	Yes
Time	Time control	< 10 hr, Pulse, or Continuous	< 100 hr, Pulse, or Continuous
	Time counting	Selectable, "at set speed" or "from starting"	Selectable, "at set speed" or "from starting"
Program memory		100	100
Noise level		< 60 dB	< 60 dB
Imbalance cutoff		Yes	Yes
Rotor identification		-	Automatic
Dimension (W x D x H, mm)		375 x 507 x 265	584 x 554 x 313
Weight		25.7 kg	65.7 kg
Power requirement		340 VA	900 VA
Power input (V,Hz)		210 V ~ 240 V, 50/60 Hz (110 V optional)	210 V ~ 240 V, 50/60 Hz (110 V optional)
Cat. No.		T04B / T04B-md	T05R / T05R-md

Fixed Angle Rotors for T Series (1)

Rotor	Sleeve	Adaptable Centrifuge	Tube Capacity Bottom Type	Required Adaptor	Bore Ø x L (mm) Radius (mm)	Max. RPM (rpm) Max. RCF (xg)					
AO-50-10  Max. RPM : 4,000 rpm Hole angle : ∠45° Max. Capacity : 10 x 50 mL or 50 mL Conical Size (ø x H) : ø197 x 59 mm	B50-SS 	T04B	 50 mL Round/Skirt - 30.2 x 94 142.5 4,000 2,549	 50mL Conical TR50c(50f)  29.5 x 17.5 142.5 4,000 2,549	 30mL Round TR30(50f)  26 x 86.5 135 4,000 2,415	 25mL Conical TR25c(50f)  28.8 x 14.1 115 4,000 2,057	 15 mL Round/Conical TR15(50f)  17.2 x 87 141.9 4,000 2,538	 14mL Round TR14(50f)  17.2 x 75 141.9 4,000 2,538			
			A-50-10  Max. RPM : 5,000 rpm Hole angle : ∠45° Max. Capacity : 10 x 50 mL or 50 mL Conical Size (ø x H) : ø197 x 59 mm	Hole dimension (Ø x L,mm) : 30.2 x 94 Max. height for tube fit : 130	T05R	 50 mL Round/Skirt - 30.2 x 94 142.5 5,000 3,983	 50mL Conical TR50c(50f)  29.5 x 17.5 142.5 5,000 3,983	 30mL Round TR30(50f)  26 x 86.5 135 5,000 3,773	 25mL Conical TR25c(50f)  28.8 x 14.1 115 5,000 3,214	 15 mL Round/Conical TR15(50f)  17.2 x 87 141.9 5,000 3,966	 14mL Round TR14(50f)  17.2 x 75 141.9 5,000 3,966

* Radius : From the center of the rotor to the inner end of tube carrier.

Fixed Angle Rotors for T Series (2)

Rotor		Sleeve	Adaptable Centrifuge	Tube Capacity Bottom Type	Required Adaptor	Bore Ø x L (mm) Radius (mm)	Max. RPM (rpm) Max. RCF (xg)
AO-50c-10  Max. RPM : 4,000 rpm Hole angle : ∠45° Max. Capacity : 10 x 50 mL or 50 mL Conical Size (ø x H) : ø197 x 59 mm	B50c-SS 	T04B	 50 mL Conical	-	30.2 x 99 140	4,000 2,508	
			 50mL Round	TR50(50c) 	29 x 11 136.1	4,000 2,435	
			 30mL Round	TR30(50c) 	26 x 83.8 135.5	4,000 2,424	
			 25mL Conical	TR25c(50c) 	28.8 x 14.1 115	4,000 2,057	
			 15 mL Conical	TR15c(50c) 	17.2 x 105 139.6	4,000 2,497	
A-50c-10  Max. RPM : 5,000 rpm Hole angle : ∠45° Max. Capacity : 10 x 50 mL or 50 mL Conical Size (ø x H) : ø197 x 59 mm	Hole dimension (Ø x L,mm) : 30.2 x 94 Max. height for tube fit : 130	T05R	 50 mL Conical	-	29 x 11 136.1	5,000 3,913	
			 50mL Round	TR50(50c) 	26 x 83.8 135.5	5,000 3,804	
			 30mL Round	TR30(50c) 	28.8 x 14.1 115	5,000 3,787	
			 25mL Conical	TR25c(50c) 	17.2 x 105 139.6	5,000 3,214	
			 15 mL Conical	TR15c(50c) 	17.2 x 105 139.6	5,000 3,902	
AO-15-24  Max. RPM : 4,000 rpm Hole angle : ∠45° Max. Capacity : 24 x 15 mL Size (ø x H) : ø223 x 59 mm	B15 	T04B	 15mL	-	18 x 87 155	4,000 2,773	
			 14mL Round	TR14(15f) 	16.5 x 7 142.5	4,000 2,549	
			 5mL conical	TR5c(15f) 	16 x 20 121.3	4,000 2,170	
			 5mL Round	TR5(15f) 	13.5x85 152.8	4,000 2,733	
			 3mL Round	TR3(15f) 	13.5 x 61 132.3	4000 2,367	
A-15-24  Max. RPM : 4,500 rpm Hole angle : ∠45° Max. Capacity : 24 x 15 mL Size (ø x H) : ø223 x 59 mm	Hole dimension (Ø x L,mm) : 18 x 87 Max. height for tube fit : 125(120 for conical / wider cap)	T05R	 15mL	-	18 x 87 155	4,500 3,509	
			 14mL Round	TR14(15f) 	16.5 x 7 142.5	4,500 3,226	
			 5mL conical	TR5c(15f) 	16 x 20 121.3	4,500 2,746	
			 5mL Round	TR5(15f) 	13.5x85 152.8	4,500 3,459	
			 3mL Round	TR3(15f) 	13.5 x 61 132.3	4,500 2,995	

* Radius : From the center of the rotor to the inner end of tube carrier.

Micro Centrifuges

T04B / T05R / Combi 508 / Combi R515

Swing-out Rotors for T series

SO/S-100-4

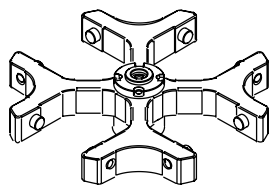

∠ 90°
Max.RPM : 4,000rpm
Size (Ø x H) : 206.3x 46 mm

Bucket for SO/S-100-4



Round Bucket
BB100b-100
cap included

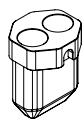

Conical Bucket
Bd50c-100

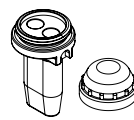



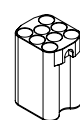





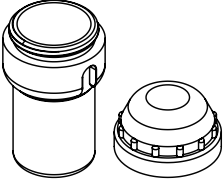





Conical Bucket
BBd15cb-100
cap included



Bucket
BB100b-100
cap included

Buckets and Tube Racks of SO/S-100-4











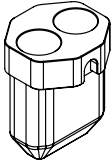









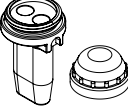



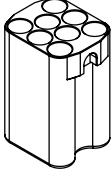

Bucket	Required Adaptor	Tube Capacity Bottom Type	Tube per Adaptor / Rotor	Bore (Ø x L, mm)	Max. height for tube fit (mm)	T04B Max. RPM (rpm) Max. RCF (xg)	T05R Max. RPM (rpm) Max. RCF (xg)
BB100b-100 	TR100(100)	 100mL Round	1 / 4	44.2 x 93	125(w/o cap)	4,000 2,685	4,500 3,398
	TR85(100)	 85mL Round	1 / 4	38.5 x 106	118	4,000 2,739	4,500 3,466
	TR50sc(100)	 50mL Skirt	1 / 4	29.8 x 100	117	4,000 2,721	4,500 3,443
	TR50c(100)	 50mL Conical	1 / 4	30 x 103	117	4,000 2,721	4,500 3,443
	TR50(100)	 50mL Round	1 / 4	29.5 x 95.9	118	4,000 2,739	4,500 3,466
	TR30(100)	 30mL Round	1 / 4	26 x 86	118	4,000 2,739	4,500 3,466
	TR25c(100)	 25mL Conical	1 / 4	29.8 x 62	118	4,000 2,739	4,500 3,466
	TR15c(100)	 15mL Conical	1 / 4	17.2 x 108	120	4,000 2,774	4,500 3,511
	TR15c-3(100)	 15mL Conical	3 / 12	17.2 x 108	130(w/o cap)	4,000 2,774	4,500 3,511
	TR15-3(100)	 15mL Round	3 / 12	17.5 x 105	127(w/o cap)	4,000 2,721	4,500 3,443
	TR10-5(100)	 10mL	5 / 20	16.1 x 60	115	4,000 2,685	4,500 3,398
	TR7-5(100)	 7mL	5 / 20	13.5 x 60	115	4,000 2,685	4,500 3,398
	TR5c-3(100)	 5mL Conical	3/12	17.2 x 52	75	4,000 1,965	4,500 2,493
TR2-6(100)	 1.5mL/ 2mL	6 / 24	11.1 x 39	115	4,000 2,685	4,500 3,398	

Radius : 155.1mm
Bucket bore(Ø x L, mm) : 47 x 99
Max.height for tube fit : 120(w/
cap) / 130(w/o cap)

* Radius : From the center of the rotor to the inner end of tube carrier.

Multi-purpose Centrifuges

T04B / T05R / Combi 508 / Combi R515

Bucket	Required Adaptor	Tube Capacity Bottom Type	Tube per Adaptor / Rotor	Bore (Ø x L, mm)	Max. height for tube fit (mm)	T04B Max. RPM (rpm) Max. RCF (xg)	T05R Max. RPM (rpm) Max. RCF (xg)	
Bd50c-100  Radius : 155.1mm Bucket bore(Ø x L, mm) : 30 x 89 Max.height for tube fit : 125	-	 50mL Conical	2/8		125	4,000 2,774	4,500 3,511	
	TR50(50c) 	 50mL Round			29 x 11	114.5	4,000 2,588	4,500 3,276
	TR30(50c) 	 30mL Round			26 x 83.8	114.5	4,000 2,592	4,500 3,280
	TR25c(50c) 	 25mL Conical			28.8 x 14.1	87	4,000 2,102	4,500 2,660
	TR15c(50c) 	 15mL Conical			17.2 x 105	125	4,000 2,774	4,500 3,511
BBd15cb-100  Radius : 155.1mm Bucket bore(Ø x L, mm) : 17 x 97.5 Max.height for tube fit : 120 (w/ cap) / 125 (w/o cap)	-	 15mL Conical	2/8		120	4,000 2,774	4,500 3,511	
	TR14(15c) 	 14mL Round			16 x 7.8	96	4,000 2,352	4,500 2,977
	TR5c(15c) 	 5mL Conical			16 x 20	62.4	4,000 1,746	4,500 2,210
B15-8-100  Radius : 152mm Bucket bore(Ø x L, mm) : 17 x 86 Max.height for tube fit : 125	-	 15mL/ 10mL VT	2/8	17 x 86	115	4,000 2,719	4,500 3,441	
	TR14(15f) 	 14mL Round	4/16	16.5 x 7	103.5	4,000 2,513	4,500 3,181	
	TR5c(15f) 	 5mL Conical	4/16	16 x 20	75	4,000 2,003	4,500 2,536	
	TR5(15f) 	 5mL	8/32	13.5 x 85	115	4,000 2,719	4,500 3,545	
	TR3(15f) 	 3mL	8/32	13.5 x 61	88	4,000 2,236	4,500 2,830	

* Radius : From the center of the rotor to the inner end of tube carrier.

Micro Centrifuges

T04B / T05R / Combi 508 / Combi R515

Swing-out Rotors for T series

SO/S-50-4

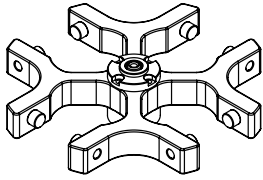

∠ 90°
Max.RPM : 4,000rpm
Size (Ø x H) : 206.3x 46 mm

Bucket for SO/S-50-4

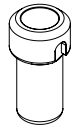

Round Bucket
B50-50

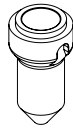



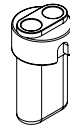

























Conical Bucket
B50c-50



Conical Bucket
Bd15c-50

Buckets and Tube Racks of SO/S-100-4

Bucket	Required Adaptor	Tube Capacity Bottom Type	Bore (Ø x L, mm)	Max. height for tube fit (mm)	T04B Max. RPM (rpm) Max. RCF (xg)	T05R Max. RPM (rpm) Max. RCF (xg)
B50-50  Radius : 150.9mm Bucket bore(Ø x L, mm) : 30.5 x 86 Max.height for tube fit : 125		 50mL Round/Skirt	30.5 x 86	125	4,000 2,700	5,000 4,218
	TR50c(50f) 	 50mL Conical	29.5 x 15.6	125	4,000 2,700	5,000 4,218
	TR30(50f) 	 30mL Round	26 x 86.5	118.5	4,000 2,583	5,000 4,036
	TR25c(50f) 	 25mL Conical	26.8 x 14.1	91.5	4,000 2,107	5,000 3,293
	TR15(50f) 	 15mL Round/Conical	17.2 x 87	125	4,000 2,700	5,000 4,218
	TR14(50f) 	 14mL Round	17.2 x 75	125	4,000 2,700	5,000 4,218
B50c-50  Radius : 150.9mm Bucket bore(Ø x L, mm) : 29.5 x 91.5 Max.height for tube fit : 125		 50mL Conical	29.5 x 91.5	125	4,000 2,700	5,000 4,218
	TR50(50c) 	 50mL Round	29 x 11	114.5	4,000 2,513	5,000 3,927
	TR30(50c) 	 30mL Round	26 x 83.8	114.5	4,000 2,517	5,000 3,933
	TR25c(50c) 	 25mL Conical	28.8 x 14.1	87	4,000 2,027	5,000 3,167
	TR15c(50c) 	 15mL Round/Conical	17.2 x 105	125	4,000 2,700	5,000 4,218
Bd15c-50  Radius : 150.9mm Bucket bore(Ø x L, mm) : 17 x 91.5 Max.height for tube fit : 120		 15mL Conical	17 x 91.5	120	4,000 2,700	5,000 4,218
	TR14(15c) 	 14mL Round	16 x 7.8	96	4,000 2,277	5,000 3,558
	TR5c(15c) 	 5mL Conical	16 x 20	62.5	4,000 1,671	5,000 2,611

* Radius : From the center of the rotor to the inner end of tube carrier.

Swing-out Rotors for T series

SO/S-15-6

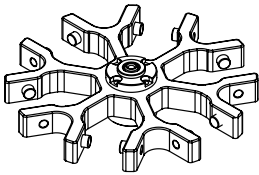





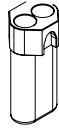

∠ 90°
Max.RPM : 4,000rpm
Size (Ø x H) : 198.2x 44 mm

Bucket for SO/S-15-6



Round Bucket
Bd15-15

Buckets and Tube Racks of SO/S-15-6

Bucket	Required Adaptor	Tube Capacity Bottom Type	Tube per Adaptor / Rotor	Bore (Ø x L, mm)	Max. height for tube fit (mm)	T04B Max. RPM (rpm) Max. RCF (xg)	T05R Max. RPM (rpm) Max. RCF (xg)
Bd15-15  Radius : 153mm Bucket bore(Ø x L, mm) : 17 x 88 Max.height for tube fit : 122	-	 10mL/ 15mL	2/12	17 x 88	123	4,000 2,737	4,400 3,312
	TR5(15f) 	 5mL	2/12	13.5 x 85	123	4,000 2,737	4,400 3,312
	TR3(15f) 	 3mL	2/12	13.5 x 61	95	4,000 2,164	4,400 2,727

* Radius : From the center of the rotor to the inner end of tube carrier.

Swing-out Rotors for T series

SO/S-mw-2

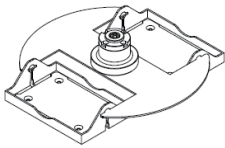

∠ 90°
Max.RPM : 4,000rpm
Size (Ø x H) : 240x 46mm

Buckets and Tube Racks of SO/S-mw-2

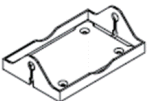
Bucket	Tube Capacity	Tube per Adaptor / Rotor	Max. RPM (rpm) Max. RCF (xg)
P-mw  Radius : 111.8 size (w x d ,mm) : 86.5 x 128.5 Max. height for tube fit (mm) : 6	MTP/WP	1/2	4,000 2,000

* Radius : From the center of the rotor to the inner end of tube carrier.

Multi-purpose Centrifuges

T04B / T05R / Combi 508 / Combi R515

Multi-purpose Centrifuge

Combi 508

- Compact benchtop, multi-purpose centrifuge
- Ideal for routine usage of 4 x 750 mL swing-out centrifugation
- Very quiet and static operation with BLDC motor
- The extensive range of accessories can accommodate tubes from 0.2 mL to 750 mL as well as microtiter plates.
- Automatic rotor identification
- Imbalance cutoff and tracking
- Intuitive and easy control and informative display
- Smooth operation with motorized lid opening and closure

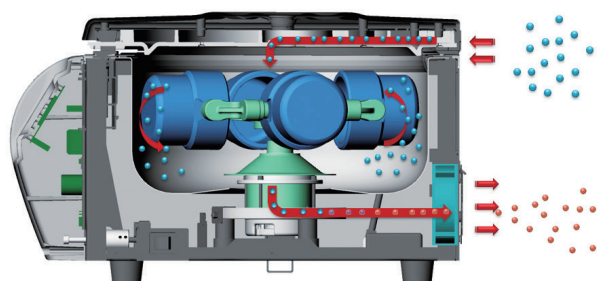
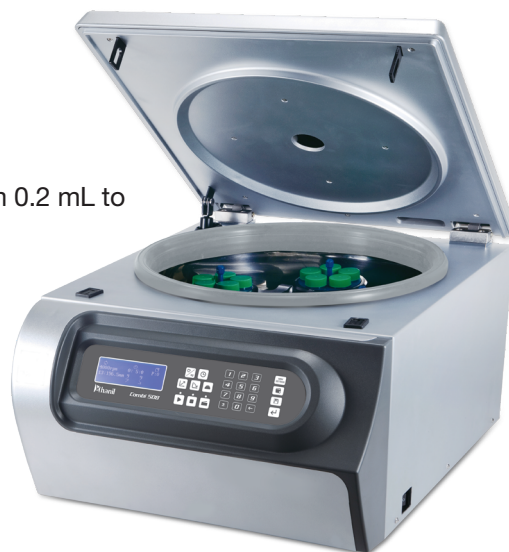

Unique air flow structure for effective noise reduction and excellent cooling

Technical Specifications

		Combi 508 / Combi 408*	Combi R515 / Combi 514R*
Speed RCF (xg)	Max. RPM (Fixed angle)	8,000 rpm	15,000 rpm
	Max. RCF (Fixed angle)	8,279 xg	25,353 xg
	Max. RPM (Swing-out)	4,000 rpm	4,500 rpm
	Max. RCF (Swing-out)	3,515 xg	4,392 xg
Max. capacity	Fixed angle	6 x 85 mL	6 x 250 mL, 36 x 1.5 / 2.0 mL
	Swing-out	4 x 750 mL	4 x 750 mL, 76 x 15 mL, 4 MTPs
ACC/DEC ramps		10/10 steps	
Temperature range		-	-10°C to 40°C
Time control		< 2 hr, continuous	< 100 hr, pulse, continuous
Program memory		100	
Noise level		≤ 65 dB	≤ 65 dB
Imbalance cutoff / tracking		Yes / Yes	Yes / Yes
Rotor identification		Automatic	Automatic
Dimension (W x D x H, mm)		530 x 676 x 400	723 x 665 x 387
Weight without rotor		61 kg	95 kg
Power consumption		2.1 kVA	2.5 kw
Power supply (V/Hz)		210 V ~ 240 V, 50 / 60 Hz (110 V optional)	210 V~240 V, 50 / 60 Hz (110 V optional)
Cat. No.		CB-508 / CB-408	CB-R515 / CB-514R

* Registered as medical device at MFDS¹⁾

¹⁾ MFDS : Ministry of Food and Drug Safety (KOREA)

Multi-purpose Centrifuge

Combi R515

- Multi-purpose centrifuge for using both fixed angle and swing-out rotors
- Robust and practical benchtop design
- Performance up to 15,000 rpm (24,000 xg) with 6 x 85 mL rotor
- Can be used with many different rotors and adaptors for a wide variety of applications
- Large capacity swing-out rotor for 4 x 500 mL up to 4,500 rpm (4,300 xg)
- The extensive range of accessories can accommodate tubes from 0.2 ml to 750 ml as well as microtiter plates.
- Automatic rotor identification prevents overspeed
- Imbalance cutoff and tracking
- Intuitive and easy control and extensively informative display
- Smoothly working motorized lid opening and closure
- Excellent temperature control
- Built-in condensation drain to eliminate water accumulation
- Password lock function

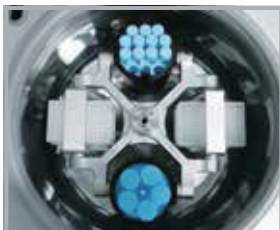

S750-4 / B750 & TM96



S500-4 / B500 & TM96



A50-8









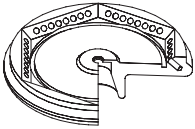
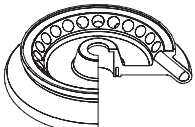

A0.2-48

Multi-purpose Centrifuges

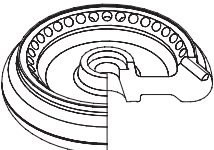



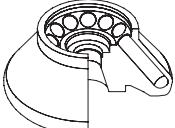
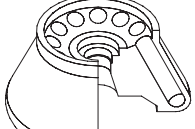
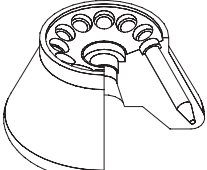





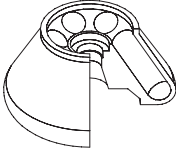

















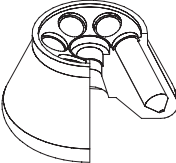







T04B / T05R / Combi 508 / Combi R515

Fixed Angle Rotors for Combi Series (1)

Rotor	Adaptable Centrifuge	Tube Capacity Bottom Type	Required Adaptor	Bore Ø x L (mm) Radius (mm)	Max. RPM (rpm) Max. RCF (xg)	
A0.2-48  Hole angle : $\angle 45^\circ$ Max. Capacity : 48 x 0.2 mL Size (ø x H) : ø200 x 56 mm Incl. a coupling bolt lid	Combi R515	0.2 mL -	-	6.5 x 17 88.9	12,500 15,531	
		0.2 mL PCR strip	-			
	Combi 508	0.2 mL -	-	6.5 x 17 88.9	8,000 6,361	
		0.2 mL PCR strip	-			
A2.0-24  Hole angle : $\angle 40^\circ$ Max. Capacity : 24 x 1.5/2.0 mL Size (ø x H) : ø202 x 79 mm Max. height for tube fit : 46 mm Incl. a coupling bolt lid	Combi R515	1.5/2.0 mL -	-	11 x 37.5 80.8	15,000 20,325	
		0.5 mL -	TR0.5(2)		8 x 31 76.5	15,000 19,244
		0.2 mL -	TR0.2(2)		6.5 x 23 67	15,000 16,854
	Combi 508	1.5/2.0 mL -	-	-	11 x 37.5 80.8	8,000 5,781
		0.5 mL -	TR0.5(2)		8 x 31 76.5	8,000 5,473
		0.2 mL -	TR0.2(2)		6.5 x 23 67	8,000 4,795
A2.0-36  Type : Fixed Angle Rotor $\angle 30^\circ$ Max. Capacity : 36 x 1.5/2.0 mL Size (ø x H) : ø240 x 64 mm Max. height for tube fit : 49 mm Incl. a coupling bolt lid	Combi R515	1.5/2.0 mL Micro-filter tube	-	11 x 37.5 115.7	14,000 25,353	
		0.5 mL	TR0.5(2)		8 x 31 111	14,000 24,323
		0.2 mL	TR0.2(2)		6.5 x 23 100	14,000 21,913
	Combi 508	1.5/2.0 mL Micro-filter tube	-	-	11.5 x 37.5 115.7	8,000 8,279
		0.5 mL	TR0.5(2)		8 x 31 111	8,000 7,942
		0.2 mL	TR0.2(2)		6.5 x 23 100	8,000 7,155
A10-12  Hole angle : $\angle 36^\circ$ Max. Capacity : 12 x 10 mL Size (ø x H) : ø179.9 x 82 mm Max. height for tube fit : 87.1 mm Incl. a coupling bolt lid	Combi R515	10 mL Round	-	16.3 x 74.5 85.1	15,000 21,407	
	Combi 508				8,000 6,089	
A15S-12  Hole angle : $\angle 25^\circ$ Max. Capacity : 12 x 15 mL Size (ø x H) : ø205 x 109 mm Max. height for tube fit : 109.5 mm Incl. a coupling bolt lid	Combi R515	15(16) mL Round	-	19 x 96 96.1	15,000 24,174	
	Combi 508				8,000 6,876	
A15c-12  Hole angle : $\angle 25^\circ$ Max. Capacity : 12 x 15 mL conical Size (ø x H) : ø215 x 121 Max. height for tube fit : 123.2 mm Incl. a coupling bolt lid	Combi R515	15 mL Conical	-	17.2 X 110 99.4	15,000 25,004	
	Combi 508				8,000 7,105	

* Radius : From the center of the rotor to the inner end of tube carrier.

Fixed Angle Rotors for Combi Series (2)











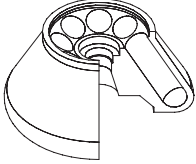

















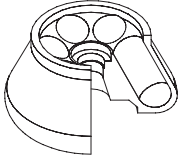















Rotor	Adaptable Centrifuge	Tube Capacity Bottom Type	Required Adaptor	Bore Ø x L (mm) Radius (mm)	Max. RPM (rpm) Max. RCF (xg)
A50-6  Hole angle : $\angle 30^\circ$ Max. Capacity : 6 x 50 mL Size (Ø x H) : $\phi 200 \times 109$ mm Max. height for tube fit : 122.7 mm Incl. a coupling bolt lid	Combi R515	 50 mL Round -		29.5 x 100 96.1	15,000 24,174
		 30mL Round TR30(50)		26 x 83.8 90.4	15,000 22,740
		 25mL Conical TR25c(50)		27.1 x 14.1 76	15,000 19,118
		 15 mL Round TR15(50)		17 x 94 89.9	15,000 22,614
		 15 mL Conical TR15c(50)		17.2 x 105 91	15,000 22,891
	Combi 508	 50 mL Round -		29.5 x 100 96.1	8,000 6,876
		 30mL Round TR30(50)		26 x 83.8 90.4	8,000 6,468
		 25mL Conical TR25c(50)		27.1 x 14.1 76	8,000 5,438
		 15 mL Round TR15(50)		17 x 94 89.9	8,000 6,433
		 15 mL Conical TR15c(50)		17.2 x 105 91	8,000 6,511
A50c-6  Hole angle : $\angle 23^\circ$ Max. Capacity : 6 x 50 mL conical Size (Ø x H) : $\phi 205.7 \times 119$ mm Max. height for tube fit : 118.5 mm Incl. a coupling bolt lid	Combi R515	 50 mL Conical -		29.8 x 108.6 91	15,000 22,891
		 50mL Round TR50(50c)		29 x 11 88.5	15,000 22,262
		 30mL Round TR30(50c)		26 x 83.8 87.5	15,000 22,011
		 25 mL Conical TR25c(50c)		29 x 14.1 75.5	15,000 18,992
		 15 mL Conical TR15c(50c)		17 x 94 86.2	15,000 21,684
	Combi 508	 50 mL Conical -		29.8 x 108.6 91	8,000 6,511
		 50mL Round TR50(50c)		29 x 11 88.5	8,000 6,332
		 30mL Round TR30(50c)		26 x 83.8 87.5	8,000 6,261
		 25 mL Conical TR25c(50c)		29 x 14.1 75.5	8,000 5,402
		 15 mL Conical TR15c(50c)		17 x 94 86.2	8,000 6,168

* Radius : From the center of the rotor to the inner end of tube carrier.

Multi-purpose Centrifuges











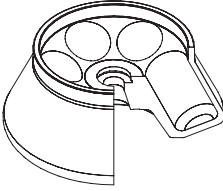

















T04B / T05R / Combi 508 / Combi R515

Fixed Angle Rotors for Combi Series (3)

Rotor	Adaptable Centrifuge	Tube Capacity Bottom Type	Required Adaptor	Bore Ø x L (mm) Radius (mm)	Max. RPM (rpm) Max. RCF (xg)
A50-8  Hole angle : $\angle 30^\circ$ Max. Capacity : 8 x 50 mL Size (ø x H) : ø213 x 110.7 mm Max. height for tube fit : 110.7 mm Incl. a coupling bolt lid	Combi R515	 50 mL Round	-	29.5 x 100 98.9	15,000 24,878
		 30 mL Round	TR30(50) 	26 x 83.8 93.2	15,000 23,444
		 25 mL Conical	TR25c(50) 	27.1 x 14.1 78.8	15,000 19,822
		 15 mL Round	TR15(50) 	17 x 94 92.8	15,000 23,344
		 15 mL Conical	TR15c(50) 	17.2 x 105 93.9	15,000 23,621
	Combi 508	 50 mL Round	-	29.5 x 100 98.9	8,000 7,077
		 30 mL Round	TR30(50) 	26 x 83.8 93.2	8,000 6,669
		 25 mL Conical	TR25c(50) 	27.1 x 14.1 78.8	8,000 5,639
		 15 mL Round	TR15(50) 	17 x 94 92.8	8,000 6,640
		 15 mL Conical	TR15c(50) 	17.2 x 105 93.9	8,000 6,719
A85-6  HHole angle : $\angle 25^\circ$ Max. Capacity : 6 x 85 mL Size (ø x H) : ø209.1 x 112 mm Max. height for tube fit : 115.4 mm Incl. a coupling bolt lid	Combi R515	 85 mL Round	-	38.5 x 95 97.6	15,000 24,551
		 50 mL Conical	TR50c(85) 	29.5 x 98 93	15,000 23,394
		 50 mL Round	TR50(85) 	29.2 x 95 92.9	15,000 23,369
		 30 mL Round	TR30(85) 	26 x 85.4 91.6	15,000 23,042
		 25 mL Conical	TR25c(85) 	29.5 x 62.5 80.3	15,000 20,199
		 15 mL Round	TR15(85) 	17 x 94 89	15,000 22,388
		 15 mL Conical	TR15c(85) 	17 x 98 89.2	15,000 22,438
	Combi 508	 85 mL Round	-	38.5 x 95 97.6	8,000 6,983
		 50 mL Conical	TR50c(85) 	29.5 x 98 93	8,000 6,654
		 50 mL Round	TR50(85) 	29.2 x 95 92.9	8,000 6,647
		 30 mL Round	TR30(85) 	26x85.4 91.6	8,000 6,554
		 25 mL Conical	TR25c(85) 	29.5 x 62.5 80.3	8,000 5,746
		 15 mL Round	TR15(85) 	17 x 94 89	8,000 6,368
 15 mL Conical	TR15c(85) 	17 x 98 89.2	8,000 6,382		

* Radius : From the center of the rotor to the inner end of tube carrier.

Fixed Angle Rotors for Combi Series (4)

Rotor	Adaptable Centrifuge	Tube Capacity Bottom Type	Required Adaptor	Bore Ø x L (mm) Radius (mm)	Max. RPM (rpm) Max. RCF (xg)										
A250-6  Hole angle : $\angle 25^\circ$ Max. Capacity : 6 x 250 mL Size (ø x H) : ø295.6 x 147.8 mm Max. height for tube fit : 132 mm Incl. a coupling bolt lid	Combi R515	 250mL Flat - 62 x 103 138.3 8,000 9,896	 100mL Round TR100(250)  44.2 x 93 124.5 8,000 8,908	 85mL Round TR85(250)  38.5 x 96 122.5 8,000 8,765	 50mL Conical (Skirt) TR50sc(250)  29.8 x 93 125 8,000 8,944	 50mL Conical TR50c(250)  29.8 x 98 119 8,000 8,515	 50mL Round TR50-2(250)  29.5 x 90 120 8,000 8,586	 30mL Round TR30-3(250)  26 x 85 132.5 8,000 9,481	 25mL Conical TR25c(250)  29.5 x 61.5 120 8,000 8,586	 15mL Conical TR15c-4 (250)  17.2 x 104.5 131 8,000 9,373	 15mL Round TR15-4(250)  17.5 x 103.5 133.5 8,000 9,552	 10mL Round TR10-7(250)  16 x 80 133.5 8,000 9,552	 5mL Round TR7-8(250)  13.5 x 60 135.5 8,000 9,695	 5mL Conical TR5c-4(250)  17.2 x 50 131 8,000 9,373	 1.5mL/2mL TR2.0-9(250)  11.1 x 39 135 8,000 9,660

* Radius : From the center of the rotor to the inner end of tube carrier.

Multi-purpose Centrifuges

T04B / T05R / Combi 508 / Combi R515

Swing-out Rotors for Combi Series

S750-4

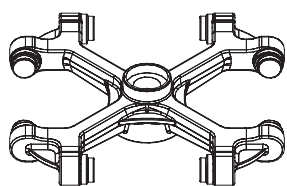

∠90°

Max. RPM : 4,000 rpm

Size (W x D x H)

: 277 x 277 x 55 mm

Bucket/Adaptor for S750-4

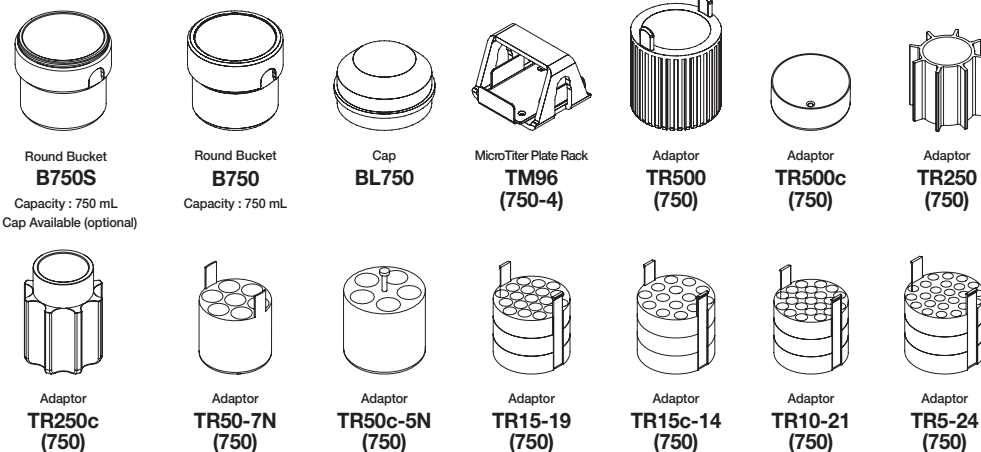

Buckets and Tube Racks of S750-4

Bucket	Required Adaptor	Tube Capacity Bottom Type	Tube per Adaptor / Rotor	Bore (Ø x L, mm)	Max. height for tube fit (mm)		Max. RPM (rpm) Max. RCF (xg)
					w/ cap	w/o cap	
B750S / B750 BL750 	-	750 mL Flat	1 / 4	99 x 103	142	158.5	4,000 3,515
	TR500(750)	500 mL Flat	1 / 4	75.5 x 98.7	137	151.9	4,000 3,476
	TR500c(750)	500 mL conical Conical	1 / 4	99 x 58	140	155.4	4,000 3,497
	TR250(750)	250 mL Flat	1 / 4	62.3 x 87	137	152.5	4,000 3,481
	TR250c(750)	250 mL conical Conical	1 / 4	61.5 x 124.4	137.5	148.6	4,000 3,470
	TR50-7N(750)	50 mL Round	7 / 28	29.2 x 97	116.7	123.8	4,000 3,497
	TR50c-5N(750)	50 mL conical Conical	5 / 20	29 x 91	122	126	4,000 3,470
	TR15-19(750)	15 mL Round	19 / 76	17.2 x 87	129.1	136.2	4,000 3,461
	TR15c-14(750)	15 mL conical Conical	14 / 56	17 x 89	132.7	153.8	4,000 3,461
	TR10-21(750)	10 mL Round	21 / 84	16 x 87	127.7	134.8	4,000 3,461
TR5-24(750)	3 mL / 5 mL Round	24 / 96	13.2 x 60 (3 mL) 13.2 x 87 (5 mL)	123.2	129.3	4,000 3,443	
TM96(750-4) Radius : 163.5 mm MTP holder size (w x d x L, mm) : 88 x 128.5 x 42 Max. height for tube fit : 60 mm		MTP	1 / 4	88 x 128.5 x 42	60		4,000 2,925

* Radius : From the center of the rotor to the inner end of tube carrier.

S500-4

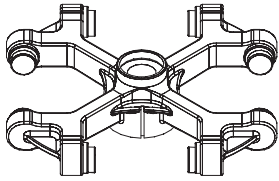

∠90°
 Max. RPM : 4,500
 Size (W x D x H)
 : 262 x 262 x 55 mm

Bucket/Adaptor for S500-4



Round Bucket
B500
 Capacity : 500 mL
 * Cap included



Cap
BL500

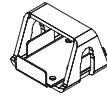

MicroTiter Plate Rack
TM96
(500-4)



Adaptor
TR500
(500)



Adaptor
TR250
(500)

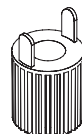

Adaptor
TR100
(500)

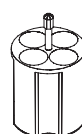

Adaptor
TR50-4
(500)

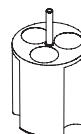

Adaptor
TR50c-3
(500)

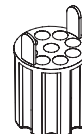

Adaptor
TR15-9
(500)

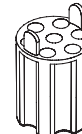

Adaptor
TR15c-7
(500)

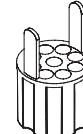

Adaptor
TR10-9
(500)

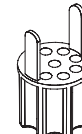

Adaptor
TR5-9
(500)

Buckets and Tube Racks of S500-4

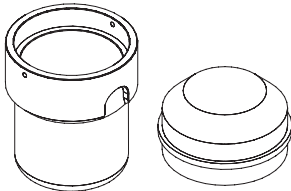
Bucket	Required Adaptor	Tube Capacity Bottom Type	Tube per Adaptor / Rotor	Bore (Ø x L, mm)	Max. height for tube fit (mm)		Max. RPM (rpm) Max. RCF (xg)	
					w/ cap	w/o cap	R515	508
 Radius : 194 mm Bucket bore (ø x L, mm) : 80 x 111 Max. height for tube fit : 144mm (w/ cap), 154 mm (w/o cap) Incl. a cap Combi R515 Max. RPM : 4,500 Max. RCF : 4,347 xg Combi 508 Max. RPM : 4,000 Max. RCF : 3,435 xg	TR500(500) 	500 mL Flat	1 / 4	73 x 125	132.6	144.1	4,500 4,392	4,000 3,470
	TR250(500) 	250 mL Flat	1 / 4	62 x 100	135.5	147.1	4,500 4,290	4,000 3,390
	TR100(500) 	100 mL (85 mL) Round	1 / 4	38.5 x 84.5	139.5	151.4	4,500 4,290	4,000 3,390
	TR50-4(500) 	50 mL Round	4 / 16	29.5 x 85.5	129.5	141.1	4,500 4,290	4,000 3,390
	TR50c-3(500) 	50 mL Conical	3 / 12	30 x 90	131.5	143.1	4,500 4,302	4,000 3,399
	TR15-9(500) 	15 mL Round	9 / 36	16.5 x 85	135.6	153.2	4,500 4,290	4,000 3,390
	TR15c-7(500) 	15 mL Conical	7 / 28	17 x 95.5	135.5	154	4,500 4,313	4,000 3,408
	TR10-9(500) 	10 mL Round	9 / 36	17 x 64	134.3	151.7	4,500 4,256	4,000 3,363
	TR5-9(500) 	5 mL Round	9 / 36	13 x 64	136.3	151.6	4,500 4,256	4,000 3,363
TM96(500-4) Radius : 154 mm MTP holder size (w x d x L, mm) : 87 x 128.5 x 53 Max. height for tube fit : 55 mm		MTP	1 / 4	87 x 128.5	55		4,000 2,755	

* Radius : From the center of the rotor to the inner end of tube carrier.

Super speed (High Speed) Centrifuges

Supra R12 / Supra R17 / Supra R22 / Supra R30 / Ultra 5.0

Super Speed Centrifuges

Supra R12

- High speed performance with high capacity
- Process up to 6 x 1000 mL
- Performance up to 12,000 rpm (22,000 xg) with 6 x 250 mL
- Wide ranges of acceleration and deceleration (10 / 10 ramps) provide excellent separations.
- Automatic rotor recognition and imbalance detection for safety operation
- Simplified operation with intuitive controls and easy-to-read displays
- Smooth operation with motorized lid opening and closure
- Excellent temperature control
- Saves up to 100 programs
- Password lock function



A1000-6

A500-6

A250-6

Technical Specifications

		Supra R12	Supra R17	Supra R22	Supra R30
Speed	Max. RPM(Fixed angle)	12,000 rpm	17,000 rpm	22,000 rpm	30,000 rpm
	Max. RCF(Fixed angle)	22,625 xg	31,050 xg	52,001 xg	99,513 xg
Max. capacity(Fixed angle)		6 x 1,000 mL	6 x 250 mL	4 x 1,000 mL	4 x 1,000 mL
ACC/DEC ramps		10 / 10 steps	9 / 10 steps	10 / 10 steps	10 / 10 steps
Temperature	Temperature range	-10°C to 40°C	-20°C to 40°C	-10°C to 40°C	-10°C to 40°C
	Fast cool	-	Yes	-	-
Time control		< 100 hr, pulse, continuous	< 100 hr, pulse, continuous	< 100 hr, continuous	< 100 hr, continuous
Program memory		100	100	100	100
Noise level		≤ 65 dB	≤ 60 dB	≤ 65 dB	≤ 65 dB
Vacuum system		-	-	-	Yes
Imbalance cutoff / tracking		Yes / Yes	Yes / -	Yes / Yes	Yes / -
Rotor identification		Automatic	Automatic	Automatic	Manual
Dimension (W x D x H, mm)		668 x 800 x 891	473 x 611 x 840	668 x 800 x 891	710 x 1,000 x 1,260
Weight		230 kg	114 kg	230 kg	415 kg
Power requirement		3.0 kVA	2.9 kVA	5.1 kVA	5.2 kVA
Power input (V,Hz)		210 V ~ 240 V, 50 / 60Hz (110V optional),	220V, 50 / 60 Hz (110 V optional)	210 V~240 V, 50 / 60 Hz (110 V optional),	210 V ~ 240 V, 50 / 60Hz (110 V optional),
Cat. No.		SU-R12	SU-R17	SU-R22	SU-R30

Super Speed Centrifuges

Supra R17

- Economical choice for daily high speed centrifuge usage
- Recommended to use conical 50 mL tubes at high speed (15,000 rpm / 22,000 xg)
- Performance up to 31,000 xg (17,000 rpm) with 6 x 50 mL rotor
- 10,000 rpm (15,000 xg) with 6 x 250 mL tubes
- Fast cool function for fast cooling
- Convenient rotor coupling and decoupling with one single action of rotor lid closure and opening (no tools required)
- Intuitive and ergonomic operation with numeric key buttons
- Selectable time counting control “at set speed” or “from starting”
- Imbalance detection for safety operation
- Compact and small foot print design



A250-6



A50c-6

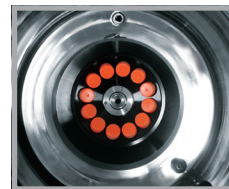

A15-12

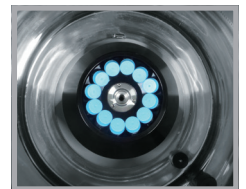

A15c-12

Super speed (High Speed) Centrifuges

Supra R12 / Supra R17 / Supra R22 / Supra R30 / Ultra 5.0

Super Speed Centrifuges

Supra R22

- Affordable high speed centrifuge for usage of 4 x 1,000 mL
- Capacity for 6 x 50ml up to 22,000 rpm (52,000 xg) and 4 x 1000 mL at 8,000 rpm (12,000 xg)
- Convenient rotor coupling and decoupling in one single action of rotor lid closure and opening (no tools required)
- Imbalance detection and tracking function
- Wide ranges of acceleration and deceleration (10 / 10 ramps) provide excellent separations
- Automatic rotor identification for safe operation
- Smoothly working, motorized lid opening and closure
- Excellent temperature control
- Password lock function



A1000-4

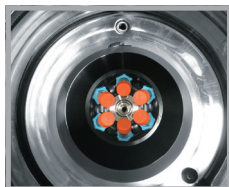

A50-6

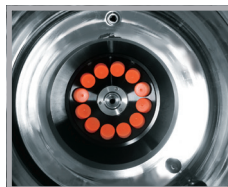

A15S-12

Super Speed Centrifuges

Supra R30

- Ideal for sub-cellular organelle separation
- Exceptional usage for 8 x 50 mL up to 30,000 rpm (almost 100,000 xg)
- Wide ranges of acceleration and deceleration (10/10 steps) provide excellent separations
- Convenient rotor coupling and decoupling complete with rotor lid closure and opening (no tools required)
- Maintenance free durable induction motor
- Soft motor shaft for stable rotation of heavy rotors
- Automatic half-atmosphere vacuum control at over 22,000 rpm
- Intuitive control panel with safety warning LEDs
- Imbalance detection and tracking function
- Robust and safe sliding lid



A1000-4



A250-6

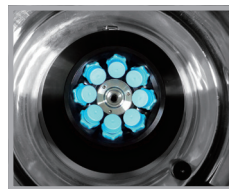

A50-8











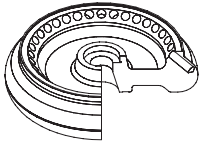



















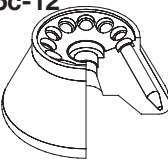

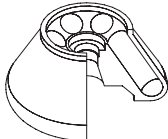



















A50c-6

Super speed (High Speed) Centrifuges

Supra R12 / Supra R17 / Supra R22 / Supra R30 / Ultra 5.0

Fixed Angle Rotors for Supra Series (1)

Rotor	Adaptable Centrifuge	Tube Capacity Bottom Type	Required Adaptor	Bore Ø x L (mm) Radius (mm)	Max. RPM (rpm) Max. RCF (xg)
A2.0-36  Hole angle : ∠30° Max. Capacity : 36 x 1.5/2.0 mL Size (ø x H) : ø240 x 64 Max. height for tube fit : 49 mm Incl. a coupling bolt lid	Supra R30	 1.5/2.0 mL Micro-filter tube	-	11 x 37.5 115.7	20,000 51,741
		 0.5 mL	TR0.5(2) 	8 x 31 111	20,000 49,639
		 0.2 mL	TR0.2(2) 	6.5 x 23 100	20,000 44,720
	Supra R22	 1.5/2.0 mL Micro-filter tube	-	11 x 37.5 115.7	18,000 41,910
		 0.5 mL	TR0.5(2) 	8 x 31 111	18,000 40,208
		 0.2 mL	TR0.2(2) 	6.5 x 23 100	18,000 36,223
	Supra R17	 1.5/2.0 mL Micro-filter tube	-	11 x 37.5 115.7	15,000 29,104
		 0.5 mL	TR0.5(2) 	8 x 31 111	15,000 27,922
		 0.2 mL	TR0.2(2) 	6.5 x 23 100	15,000 25,155
A10-12  Hole angle : ∠36° Max. Capacity : 12 x 10 mL Size (ø x H) : ø179.9 x 82 Max. height for tube fit : 87.1 mm Incl. a coupling bolt lid	Supra R30	 10 mL Round	-	16.3 x 74.5 85.1	30,000 85,628
	Supra R22				22,000 46,049
	Supra R17				17,000 27,496
A15S-12  Hole angle : ∠25° Max. Capacity : 12 x 15 mL Size (ø x H) : ø205 x 109 mm Max. height for tube fit : 109.5 mm Incl. a coupling bolt lid	Supra R30	 15 mL Round	-	19 x 96 96.1	30,000 96,696
	Supra R22				22,000 52,001
	Supra R17				17,000 31,050
A15c-12  Hole angle : ∠25° Max. Capacity : 12 x 15 mL conical Size (ø x H) : ø215 x 121 Max. height for tube fit : 123.2 mm Incl. a coupling bolt lid	Supra R30	 15 mL Conical	-	17.2 X 110 99.4	17,000 32,116
	Supra R22				17,000 32,116
	Supra R17				15,000 25,004
A50-6  Hole angle : ∠30° Max. Capacity : 6 x 50 mL Size (ø x H) : ø200 x 109 mm Max. height for tube fit : 122.7 mm Incl. a coupling bolt lid	Supra R30	 50 mL Round	-	29.5 x 100 96.1	30,000 96,696
		 30 mL Round	TR30(50) 	26 x 83.8 90.4	30,000 90,960
		 25 mL Conical	TR25c(50) 	27.1 x 14.1 76	30,000 79,471
		 15 mL Round	TR15(50) 	17 x 94 89.9	30,000 90,457
		 15 mL Conical	TR15c(50) 	17.2 x 105 91	30,000 91,564
	Supra R22	 50 mL Round	-	29.5 x 100 96.1	22,000 52,001
		 30 mL Round	TR30(50) 	26 x 83.8 90.4	20,000 48,917
		 25 mL Conical	TR25c(50) 	27.1 x 14.1 76	22,000 41,125
		 15 mL Round	TR15(50) 	17 x 94 89.9	22,000 48,646
		 15 mL Conical	TR15c(50) 	17.2 x 105 91	22,000 49,241
	Supra R17	 50 mL Round	-	29.5 x 100 96.1	17,000 31,050
		 30 mL Round	TR30(50) 	26 x 83.8 90.4	17,000 29,208
		 25 mL Conical	TR25c(50) 	27.1 x 14.1 76	17,000 24,556
		 15 mL Round	TR15(50) 	17 x 94 89.9	17,000 29,047
		 15 mL Conical	TR15c(50) 	17.2 x 105 91	17,000 29,402

* Radius : From the center of the rotor to the inner end of tube carrier.

Fixed Angle Rotors for Supra Series (2)

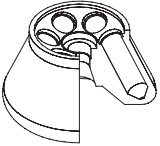
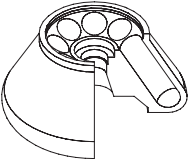
Rotor	Adaptable Centrifuge	Tube Capacity Bottom Type	Required Adaptor	Bore Ø x L (mm) Radius (mm)	Max. RPM (rpm) Max. RCF (xg)
A50c-6 		50 mL Conical	-	29.8 x 108.6 91	17,000 29,402
		50 mL Round	TR50(50c)	29 x 11 88.5	17,000 28,595
		30 mL Round	TR30(50c)	26 x 83.8 87.5	17,000 28,271
		25mL Conical	TR25c(50c)	29 x 14.1 75.5	17,000 24,394
		15mL Conical	TR15c(50c)	17 x 94 86.2	17,000 27,851
		50 mL Conical	-	29.8 x 108.6 91	15,000 22,891
		50 mL Round	TR50(50c)	29 x 11 88.5	15,000 22,261
		30 mL Round	TR30(50c)	26 x 83.8 87.5	15,000 22,011
		25 mL Conical	TR25c(50c)	29 x 14.1 75.5	15,000 18,992
		15 mL Conical	TR15c(50c)	17 x 94 86.2	15,000 21,684
A50-8 		50mL Round	-	29.5 x 100 98.9	30,000 99,513
		30mL Round	TR30(50)	26 x 83.8 93.2	30,000 93,778
		25 mL Conical	TR25c(50)	27.1 x 14.1 78.8	30,000 79,289
		15 mL Round	TR15(50)	17 x 94 92.8	30,000 93,375
		15 mL Conical	TR15c(50)	17.2 x 105 93.9	30,000 94,482
		50 mL Round	-	29.5 x 100 98.9	20,000 44,228
		30 mL Round	TR30(50)	26 x 83.8 93.2	20,000 41,679
		25mL Conical	TR25c(50)	27.1 x 14.1 78.8	20,000 35,239
		15mL Round	TR15(50)	17 x 94 92.8	20,000 41,500
		15 mL Conical	TR15c(50)	17.2 x 105 93.9	20,000 41,992
		50 mL Round	-	29.5 x 100 98.9	15,000 24,878
		30mL Round	TR30(50)	26 x 83.8 93.2	15,000 23,444
		25mL Conical	TR25c(50)	27.1 x 14.1 78.8	15,000 19,822
		15 mL Round	TR15(50)	17 x 94 92.8	15,000 23,344
		15 mL Conical	TR15c(50)	17.2 x 105 93.9	15,000 23,621

Hole angle : $\angle 23^\circ$
 Max. Capacity : 6 x 50 mL conical
 Size (ø x H) : ø205.7 x 119 mm
 Max. height for tube fit : 118.5 mm
Incl. a coupling bolt lid











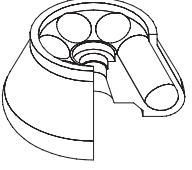





























Hole angle : $\angle 30^\circ$
 Max. Capacity : 8 x 50 mL
 Size (ø x H) : ø213 x 110.7 mm
 Max. height for tube fit : 110.7 mm
Incl. a coupling bolt lid

* Radius : From the center of the rotor to the inner end of tube carrier.

Super speed (High Speed) Centrifuges

Supra R12 / Supra R17 / Supra R22 / Supra R30 / Ultra 5.0











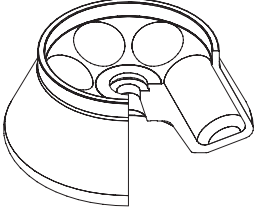















Fixed Angle Rotors for Supra Series (3)

Rotor	Adaptable Centrifuge	Tube Capacity Bottom Type	Required Adaptor	Bore Ø x L (mm) Radius (mm)	Max. RPM (rpm) Max. RCF (xg)
A85-6 	Supra R30	 85 mL Round	-	38.5 x 95 97.6	25,000 68,198
		 50 mL Conical	TR50c(85) 	29.5 x 98 93	25,000 64,984
		 50 mL Round	TR50(85) 	29.2 x 95 92.9	25,000 64,912
		 30 mL Round	TR30(85) 	26 x 85.4 91.6	25,000 64,006
		 25 mL Conical	TR25c(85) 	29.5 x 62.5 80.3	25,000 56,110
		 15 mL Round	TR15(85) 	17 x 94 89	25,000 62,189
		 15 mL Conical	TR15c(85) 	17 x 98 89.2	25,000 62,329
	Supra R22	 85 mL Round	-	38.5 x 95 97.6	20,000 43,647
		 50 mL Conical	TR50c(85) 	29.5 x 98 93	20,000 41,590
		 50 mL Round	TR50(85) 	29.2 x 95 92.9	20,000 41,545
		 30 mL Round	TR30(85) 	26 x 85.4 91.6	20,000 40,964
		 25 mL Conical	TR25c(85) 	29.5 x 62.5 80.3	20,000 35,910
		 15 mL Round	TR15(85) 	17 x 94 89	20,000 39,800
		 15 mL Conical	TR15c(85) 	17 x 98 89.2	20,000 39,890
	Supra R17	 85 mL Round	-	38.5 x 95 97.6	15,000 24,551
		 50 mL Conical	TR50c(85) 	29.5 x 98 93	15,000 23,394
		 50 mL Round	TR50(85) 	29.2 x 95 92.9	15,000 23,369
		 30 mL Round	TR30(85) 	26 x 85.4 91.6	15,000 23,042
		 25 mL Conical	TR25c(85) 	29.5 x 62.5 80.3	15,000 20,199
		 15 mL Round	TR15(85) 	17 x 94 89	15,000 22,388
		 15 mL Conical	TR15c(85) 	17 x 98 89.2	15,000 22,438

Hole angle : $\angle 25^\circ$
 Max. Capacity : 6 x 85 mL
 Size (ø x H) : ø209.1 x 112 mm
 Max. height for tube fit : 122 mm
Incl. a coupling bolt lid

* Radius : From the center of the rotor to the inner end of tube carrier.

Fixed Angle Rotors for Supra Series (4)

Rotor	Adaptable Centrifuge	Tube Capacity Bottom Type	Required Adaptor	Bore Ø x L (mm) Radius (mm)	Max. RPM (rpm) Max. RCF (xg)	
A250-6 	Supra R30 / Supra R17	250mL Flat		62 x 103 138.3	10,000 15,462	
		100mL Round	TR100(250)		44.2 x 93 124.5	10,000 13,919
		85mL Round	TR85(250)		38.5 x 96 122.5	10,000 13,696
		50mL Conical (Skirt)	TR50sc(250)		29.8 x 93 125	10,000 13,975
		50mL Conical	TR50c(250)		29.8 x 98 119	10,000 13,304
		50mL Round	TR50-2(250)		29.5 x 90 120	10,000 13,416
		30mL Round	TR30-3(250)		26 x 85 132.5	10,000 14,814
		25mL Conical	TR25c(250)		29.5 x 61.5 120	10,000 13,416
		15mL Conical	TR15c-4(250)		17.2 x 104.5 131	10,000 14,646
		15mL Round	TR15-4(250)		17.5 x 103.5 133.5	10,000 14,925
		10mL Round	TR10-7(250)		16 x 80 133.5	10,000 14,925
		5mL Round	TR7-8(250)		13.5 x 60 135.5	10,000 15,149
		5mL Conical	TR5c-4(250)		17.2 x 50 131	10,000 14,646
		1.5mL/2mL	TR2.0-9(250)		11.1 x 39 135	10,000 15,093
	Supra R22 / Supra R12	250mL Flat			62 x 103 138.3	12,000 22,265
		100mL Round	TR100(250)		44.2 x 93 124.5	12,000 20,044
		85mL Round	TR85(250)		38.5 x 96 122.5	12,000 19,722
		50mL Conical (Skirt)	TR50sc(250)		29.8 x 93 125	12,000 20,124
		50mL Conical	TR50c(250)		29.8 x 98 119	12,000 19,158
		50mL Round	TR50-2(250)		29.5 x 90 120	12,000 19,319
		30mL Round	TR30-3(250)		26 x 85 132.5	12,000 21,331
		25mL Conical	TR25c(250)		29.5 x 61.5 120	12,000 19,319
		15mL Conical	TR15c-4(250)		17.2 x 104.5 131	12,000 21,090
		15mL Round	TR15-4(250)		17.5 x 103.5 133.5	12,000 21,492
		10mL Round	TR10-7(250)		16 x 80 133.5	12,000 21,492
		5mL Round	TR7-8(250)		13.5 x 60 135.5	12,000 21,814
5mL Conical	TR5c-4(250)		17.2 x 50 131	12,000 21,090		
1.5mL/2mL	TR2.0-9(250)		11.1 x 39 135	12,000 21,734		











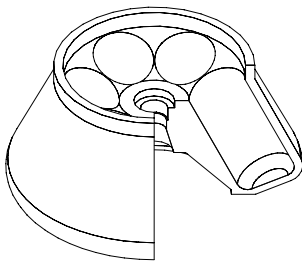









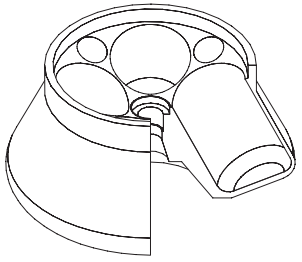





Hole angle : $\angle 25^\circ$
 Max. Capacity : 6 x 250 mL
 Size (ø x H) : ø295.6 x 147.8 mm
 Max. height for tube fit : 132 mm
Incl. a coupling bolt lid

* Radius : From the center of the rotor to the inner end of tube carrier.

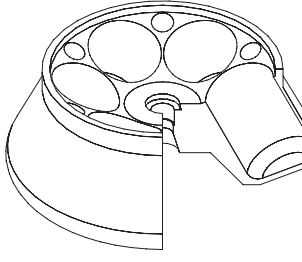
Super speed (High Speed) Centrifuges

Supra R12 / Supra R17 / Supra R22 / Supra R30 / Ultra 5.0

Fixed Angle Rotors for Supra Series (5)

Rotor	Adaptable Centrifuge	Tube Capacity Bottom Type	Required Adaptor	Bore Ø x L (mm) Radius (mm)	Max. RPM (rpm) Max. RCF (xg)
A500-6  Hole angle : $\angle 25^\circ$ Max. Capacity : 6 x 500 mL Size (ø x H) : ø336 x 179 mm Max. height for tube fit : 168.5 mm Incl. a coupling bolt lid	Supra R30	 500mL Flat	-	70 x 141 158.7	8,000 11,355
		 250mL Flat	TR250(500A) 	62 x 100 158.7	8,000 9,946
	Supra R22	 500mL Flat	-	70 x 141 158.7	9,000 14,372
		 250mL Flat	TR250(500A) 	62 x 100 158.7	9,000 142,588
	Supra R12	 500mL Flat	-	70 x 141 158.7	10,000 17,743
		 250mL Flat	TR250(500A) 	62 x 100 158.7	10,000 15,540
A1000-4  Hole angle : $\angle 25^\circ$ Max. Capacity : 4 x 1,000 mL Size (ø x H) : ø350 x 196 mm Max. height for tube fit : 184.8 mm Incl. a coupling bolt lid	Supra R30	 1000mL Flat	-	98 x 144 169.9	7,000 9,307
		 500mL Flat	TR500(1000) 	69 x 149 155.7	7,000 8,530
		 250mL Flat	TR250(1000) 	62 x 109 136.4	7,000 7,472
	Supra R22 / Supra R12	 1000mL Flat	-	98 x 144 169.9	8,000 12,157
		 500mL Flat	TR500(1000) 	69 x 149 155.7	8,000 11,141
		 250mL Flat	TR250(1000) 	62 x 109 136.4	8,000 9,760
A1000-6  Hole angle : $\angle 25^\circ$ Max. Capacity : 6 x 1,000 mL Size (ø x H) : ø408 x 188 mm Max. height for tube fit : 176.5 mm Incl. a coupling bolt lid	Supra R12	 1000mL Flat	-	98 x 144 200.1	7,000 10,962
		 500mL Flat	TR500(1000) 	69 x 149 185.9	7,000 10,184
		 250mL Flat	TR250(1000) 	62 x 109 166.6	7,000 9,127

* Radius : From the center of the rotor to the inner end of tube carrier.

Super Speed Centrifuges

Ultra 5.0

- Ideal for DNA, RNA & protein separation
- Performance up to 50,000 rpm with 12 x 13.5 mL and 6 x 38.5 mL rotors (243,000 xg and 254,000 xg)
- 8 rotor options available from 1.5 / 2.0 mL tube to 250 mL tube
- Vacuum and sealing constructed to minimize air friction at super speed rotation
- Self-lock rotor coupling, triggered by centrifugal force while spinning
- Robust and safe sliding lid
- intuitive control panel with safety warning LEDs
- Automatic rotor identification for safety

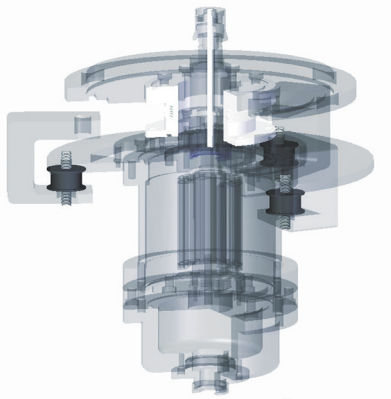

- Direct and flexible spindle drive system to endure ultra speed
- Unique anti-vibration damping structures embedded in both inside and outside motor



Super speed (High Speed) Centrifuges

Supra R12 / Supra R17 / Supra R22 / Supra R30 / Ultra 5.0

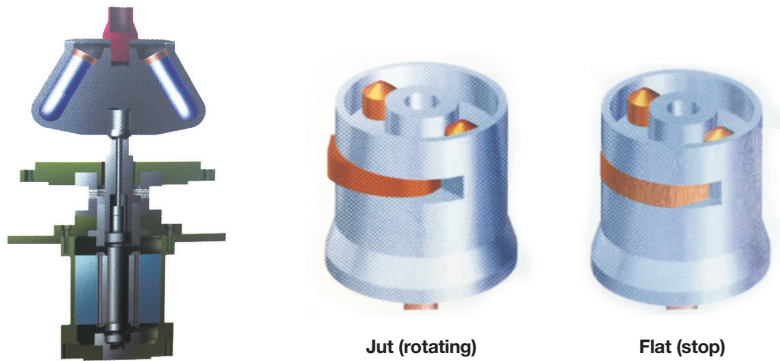

Very convenient self-lock rotor coupling, triggered by centrifugal force while spinning





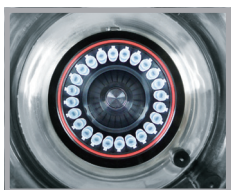





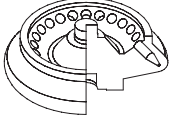
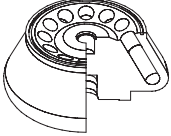

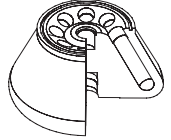

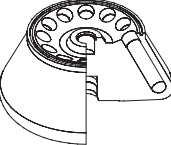
Technical Specifications

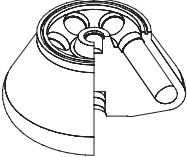
		Ultra 5.0
Speed	Max. RPM / Fixed angle	50,000 rpm
RCF (xg)	Max. RCF / Fixed angle	254,340 xg
Max. capacity / Fixed angle		6 x 250 mL
ACC/DEC		10 / 10 steps
Temperature range		-10°C to 40°C
Time control		< 100 hr, continuous
Program memory		100
Noise level		≤ 65 dB
Vacuum system		Yes
Rotor identification		Automatic
Dimension (W x D x H, mm)		710 x 1,000 x 1,260
Weight without rotor		450 kg
Power consumption		5.0 kVA
Power supply (V/Hz)		220V+ / 60 Hz (110V, 50 Hz optional)
Cat. No.		UL-5.0

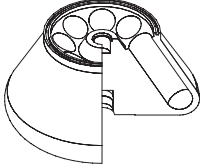

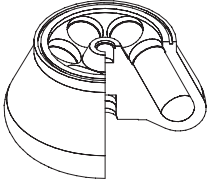
A2.0U-24

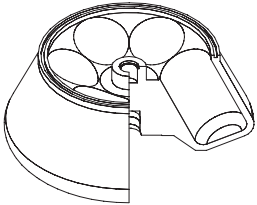
Fixed Angle Rotors for Ultra 5.0

Rotor	Tube Capacity Bottom Type (Tube Size)	Bore Ø x L (mm) Radius (mm)	Max. RPM (rpm) Max. RCF (xg)
A2.0U-24  <p>Hole angle : $\angle 40^\circ$ Max. Capacity : 24 x 1.5/2.0 mL Size (Ø x H) : $\phi 180 \times 88$ mm Max. height for tube fit : 47.1 mm Incl. a screw type lid</p>		11 x 37.5 82	40,000 146,680
A10U-12  <p>Hole angle : $\angle 26^\circ$ Max. Capacity : 12 x 10 mL Size (Ø x H) : $\phi 180 \times 90$ mm Max. height for tube fit : 71.5 mm Incl. a screw type lid</p>	 10 mL Round	16.3 X 70 80.3	45,000 182,795
A13.5U-8  <p>Hole angle : $\angle 26^\circ$ Max. Capacity : 8 x 13.5 mL Size (Ø x H) : $\phi 165.5 \times 91.3$ mm Max. height for tube fit : 84.4 mm Incl. a screw type lid</p>	 13.5 mL Round	16.3 X 83 73	50,000 204,035
A13.5U-12  <p>Hole angle : $\angle 26^\circ$ Max. Capacity : 12 x 13.5 mL Size (Ø x H) : $\phi 189 \times 90.5$ mm Max. height for tube fit : 83.4 mm Incl. a screw type lid</p>	 13.5 mL Round	16.3 X 83 87	50,000 243,160
A38.5U-6  <p>Hole angle : $\angle 30^\circ$ Max. Capacity : 6 x 38.5 mL Size (Ø x H) : $\phi 198 \times 112$ mm Max. height for tube fit : 98.9 mm Incl. a screw type lid</p>	 38.5 mL Round	25.6 x 92 91	50,000 254,340
A50U-8  <p>Hole angle : $\angle 30^\circ$ Max. Capacity : 8 x 50 mL Size (Ø x H) : $\phi 213 \times 110$ mm Max. height for tube fit : 107.3 mm Incl. a screw type lid</p>	 50 mL Round	29 x 100.5 98	30,000 98,784
A94U-6  <p>Hole angle : $\angle 25^\circ$ Max. Capacity : 6 x 94 mL Size (Ø x H) : $\phi 219.7 \times 119$ mm Max. height for tube fit : 110.7 mm Incl. a screw type lid</p>	 94 mL Round	38.5 x 105 99.4	35,000 136,377
A250U-6  <p>Hole angle : $\angle 25^\circ$ Max. Capacity : 6 x 250 mL Size (Ø x H) : $\phi 280 \times 130$ mm Max. height for tube fit : 126.9 mm Incl. a screw type lid</p>	 250 mL Flat	60 x 101 129	20,000 57,792

* Radius : From the center of the rotor to the inner end of tube carrier.

Large Capacity Centrifuges

Component wR / R6 / R12

Large Capacity Centrifuges

Component wR / R6 / R12

- Well recognized models in blood banks and large sample handling laboratories
- Optimized for consistent separation of plasma, buffy coat, RBC, etc.
- Any types of blood bags applicable from 250 mL to 500 mL
- 12 blood bags per run (Component R12), 6 blood bags per run (Component R6)
- Broad range of applications with 10 optional adapters (Component wR)
- Ideal for large number of sample handling (144 vacutainers at a time / Component wR)
- Windshield rotor to reduce the air resistance and enable to spin over 4,000 rpm
- Three step acceleration and deceleration profile for gentle and quick running
- Ergonomically arranged control and large display with comprehensive information
- Imbalance cutoff and tracking
- Accumulation of total run time and rcf (Component R12 only)
- Excellent temperature control

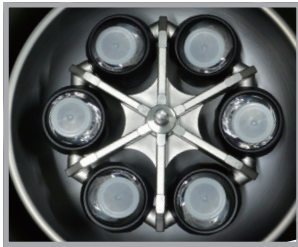

WS1000-6 / B1000

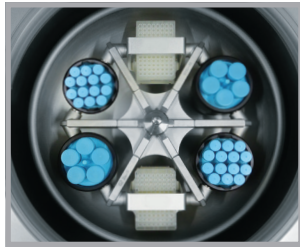

WS750-6 / B750 & TM96

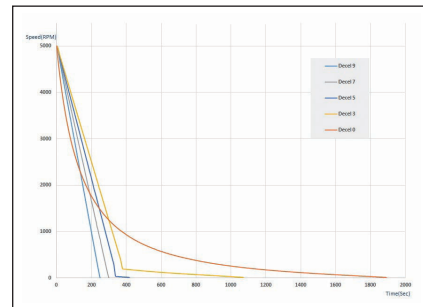

Two-step DEC control at DEC 1~5 and natural slow break at DEC 0



Component R6



Component R12



Component wR

Technical Specifications

		Component wR / Continent 512R*	Component R6 / Component R*	Component R12/Component 12R*
Speed	Max. RPM / Swing-out	4,500 rpm	5,000 rpm	4,500 rpm
	Max. RCF / Swing-out	5,096 xg	7,261 xg	6,491 xg
Max. capacity Swing-out		6 x 750 mL	6 x 1,000 mL	6 x 2,400 mL
ACC/DEC	ACC/DEC ramps	10 / 10 steps	10 / 10 steps	10 / 10 steps
	Two step Deceleration	Yes	Yes	Yes
Temperature	Temperature range	-20°C to 40°C	-20°C to 40°C	-10 to 40
	Temperature offset	Yes	Yes	Yes
Time Control		< 100 hr, pulse, continuous	< 100 hr, continuous	< 100 hr, continuous
Program memory		100	100	100
Noise level		≤ 65 dB	≤ 65 dB	≤ 65 dB
Imbalance cutoff / tracking		Yes / Yes	Yes / Yes	Yes / Yes
Rotor identification		Automatic	Automatic	Automatic
Dimension (W x D x H, mm)		668 x 800 x 891	816 x 906 x 965	840 x 980 x 970
Weight		250 kg	380 kg	480 kg
Power requirement		3.0 kw	5.0 kVA	5.72 kVA
Power input (V,Hz)		210 V ~ 240 V, 50 / 60 Hz (110 V Optional)	210V ~240V, 60 Hz (110 V, 50 Hz optional)	210 V~240 V, 60 Hz (110 V, 50 Hz optional)
Cat. No.		CP-wR / CT-512R	CP-R6 / CP-R	CP-R12 / CP-12R

* Registered as medical device at MFDS¹⁾

¹⁾ MFDS : Ministry of Food and Drug Safety (KOREA)

Large Capacity Centrifuges

Component wR / R6 / R12

Swing-out Rotor for Component R12

WS2400-6

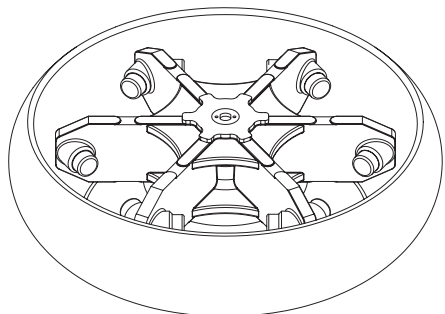

∠90°

Max. RPM : 4,500 rpm

Dim. W x D x H : 494 x 435.6 x 118 mm (w/o windshield)

Incl. a windshield and a lid

Bucket/Adaptor for WS2400-6

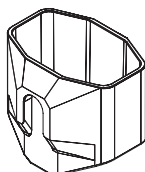

Blood Bag Bucket
B2400F

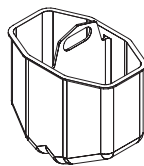

Adaptor
TRB500-2F

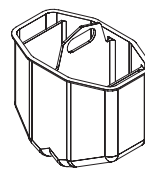



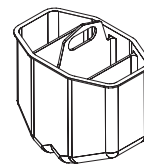



Adaptor
TRB450-2F

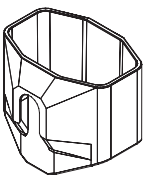

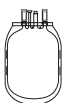
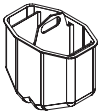
Adaptor
TRB250-2F

Bucket and Tube Racks of WS2400-6

Bucket	Required Adaptor	Tube Capacity	Tube per Adaptor / Rotor	Max. height for tube fit (mm)	Max. RPM (rpm) Max. RCF (xg)
	TRB500-2F 	 500 mL	2 / 12	209.2	4,500 6,491
	TRB450-2F 	 450 mL	2 / 12		
	TRB250-2F 	 250 mL	2 / 12		

Radius : 286.7 mm
 Bucket bore (ø x L, mm) : 178 x 142
 Max. height for tube fit: 209.2 mm

* Radius : From the center of the rotor to the inner end of tube carrier.

Swing-out Rotor for Component R6

WS1000-6

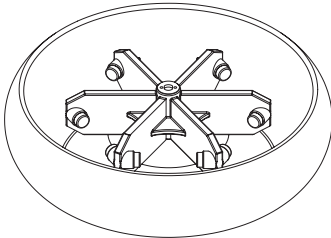

∠90°

Max. RPM : 5,000 rpm

Dim. W x D x H : 384 x 340 x 99 mm (w/o windshield)

Incl. a windshield and a lid

Bucket/Adaptor for WS1000-6



Bucket
B1000S
Capacity : 1,000 mL
* Cap Available (optional)

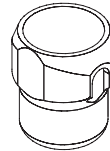

Bucket
B1000
Capacity : 1,000 mL







Cap
BL1000

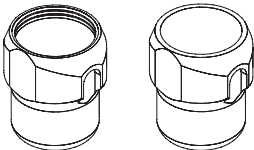

Adaptor
TRB450-1

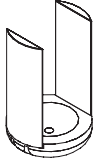
Bucket and Tube Racks of WS1000-6

Bucket	Required Adaptor	Tube Capacity Bottom Type	Tube per Adaptor / Rotor	Bore (Ø x L, mm)	Max. height for tube fit (mm)		Max. RPM (rpm) Max. RCF (xg)
					w/ cap	w/o cap	
B1000S / B1000 	-	 1,000 Flat	1 / 6	98.5 X 143	169.5	188.5	5,000 7,261
BL1000  Radius : 259.8 mm Bucket bore (ø x L, mm) : 98.5 x 143 Max. height for tube fit : 169.5 mm (w/ cap), 182.2 mm (w/o cap)	TRB450-1 	 450 mL -	1 / 6	97.5 x 156	178.7		5,000 6,842

* Radius : From the center of the rotor to the inner end of tube carrier.

Large Capacity Centrifuges

Component wR / R6 / R12

Swing-out Rotor for Component wR

WS750-6

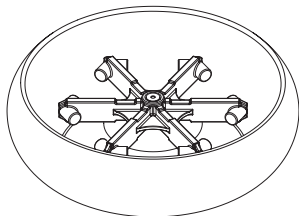

∠90°

Max. RPM : 4,500 rpm

Size (ø x H) : Ø262 x 262 mm
(w/o windshield)

Incl. a windshield and a lid

Bucket/Adaptor for WS750-6



Round Bucket
B750S

Capacity : 750 mL
* Cap Available (optional)



Round Bucket
B750

Capacity : 750 mL

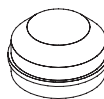

Cap
BL750

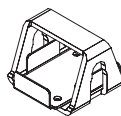

MicroTiter Plate Rack
TM96 (750-4)

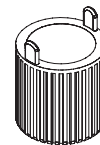

Adaptor
TR500 (750)



Adaptor
TR500c (750)

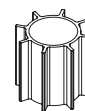

Adaptor
TR250 (750)

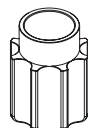

Adaptor
TR250c (750)

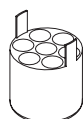

Adaptor
TR50-7N (750)

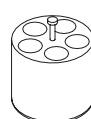

Adaptor
TR50c-5N (750)

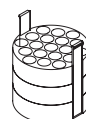

Adaptor
TR15-19 (750)

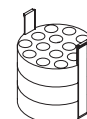

Adaptor
TR15c-14 (750)

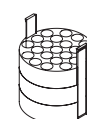



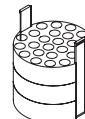





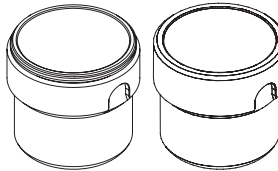
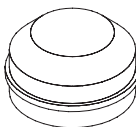















Adaptor
TR10-21 (750)

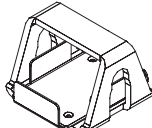

Adaptor
TR5-24 (750)

Bucket and Tube Racks of WS750-6

Bucket	Required Adaptor	Tube Capacity Bottom Type	Tube per Adaptor / Rotor	Bore (Ø x L, mm)	Max. height for tube fit (mm)		Max. RPM (rpm) Max. RCF (xg)
					w/ cap	w/o cap	
B750S / B750  BL750  Radius : 225 mm Bucket bore (ø x L,mm) : 99 x 103 Max. height for tube fit : 128 mm (w/ cap), 157.5 mm (w/o cap) Incl. a windshield and a lid	-	 750 mL Flat	1 / 6	99 x 103	128	157.5	4,500 5,096
	TR500(750) 	 500 mL Flat	1 / 6	75.5 x 98.7	124.7	141.3	4,500 5,042
	TR500c(750) 	 500 mL Conical	1 / 6	99 x 58	128	155	4,500 5,071
	TR250(750) 	 250 mL Flat	1 / 6	62.3 x 87	124	153	4,500 5,051
	TR250c(750) 	 250 mL Conical	1 / 6	61.5 x 124.4	124.5	153	4,500 5,037
	TR50-7N(750) 	 50 mL Round	7 / 42	29.2 x 97	119	125	4,500 5,026
	TR50c-5N(750) 	 50 mL Conical	5 / 30	29 x 91	120	126	4,500 5,037
	TR15-19(750) 	 15 mL Round	19 / 114	17.2 x 87	115	133.3	4,500 5,026
	TR15c-14(750) 	 15 mL Conical	14 / 84	17 x 89	113.3	122.1	4,500 5,071
	TR10-21(750) 	 10 mL Round	21 / 126	16 x 87	115	130.6	4,500 5,026
	TR5-24(750) 	 3 mL / 5 mL Round	24 / 144	13.2 x 60 (3 mL) 13.2 x 87 (5 mL)	115	137.3	4,500 5,026
	TM96(750-6) Radius : 191.9 mm MTP holder size (w x d x L, mm) : 88 x 128.5 x 42 Max. height for MTP fit : 60 mm		 MTP	1/6	88 x 128.5	60	

* Radius : From the center of the rotor to the inner end of tube carrier.

Clinical Centrifuge

T04

- Air-cooled tabletop centrifuge
- Supplied with 12-hole rotor and sleeves
- Process up to 12 vacutainer tubes or 6 x 15 mL conical tubes
- Excellently suited to the separation of blood or urine samples.
- Unique air flow design and anti-vibration structure to minimize heat and noise generation
- Lid opens automatically at the end of the run to prevent sample warming and to allow easy access to samples
- Program up to 30 routine protocols
- Durable and easy to clean with stainless steel chamber and UV resistance exterior
- Outstanding safety and durability with two layers of steel lid



AO-15/10-12













Technical Specifications

		T04 / T04-md*
Speed	Max. RPM (Fixed angle)	4,000 rpm
	Max. RCF/Fixed angle	2,075 xg
Max. capacity	Fixed angle	12 x 10 mL or 6 x 15 mL
ACC/DEC	ACC Time to Max Speed	20 sec
	DEC Time from Max Speed	20 sec
Time	Time control	< 100 min, Continuous
Program memory		30
Noise level		< 52 dB
Dimension (W x D x H, mm)		296 x 408 x 211
Weight		15 kg
Power requirement		140 VA
Power input (V,Hz)		210 V ~ 240 V, 50 / 60 Hz (110 V optional)
Cat. No.		T04 / T04-md

* Registered as medical device at MFDS¹⁾

¹⁾ MFDS : Ministry of Food and Drug Safety (KOREA)

Fixed Angle Rotors for T04

Rotor	Tube Capacity	Required Adaptor	Bore Ø x L (mm) Radius (mm)	Max. RPM (rpm) Max. RCF (xg)	
<p>AO-15/10-12</p>  <p>Hole angle : $\angle 45^\circ$ Max. Capacity : 6 x 15 mL or 12 x 10 mL Rotor dimension(Ø x L, mm) : 137.6 x 39.7 Supplied with 12 sleeves</p>	 <p>8~10 mL VT/ 15mL/ 15mL conical</p>		18 x 87 116	4,000 2,075	
	 <p>14mL Round</p>	TR14(15f)		16.5 x 7 104.5	4,000 1,869
	 <p>5mL conical</p>	TR5c(15f)		16 x 20 81.5	4,000 1,458
	 <p>4~7 mL VT</p>	TR5(15f)		13.5 x 85 111	4,000 1,986
	 <p>2.0~4 mL VT</p>	TR3(15f)		13.5 x 61 95.5	4,000 1,708
<p>B15/10</p> <p>15mL Sleeve B15/10 Hole dimension (Ø x L,mm) : 18 x 87 Hole bottom type : Flat bottom with rubber pad Max. height for tube fit (mm) : 125(120 for conical or wider cap)</p>					

* Radius : From the center of the rotor to the inner end of tube carrier.

Clinical Centrifuge

Fleta 4

- Compact centrifuge designed for effective and efficient processing of clinical samples
- Accommodate up to 24 tubes for chemical analysis of urine, blood and biological samples
- Well noted for stable separation of blood with swing-out buckets for syringe type
- Two-step deceleration to maintain finely separated sample
- Rapid acceleration and deceleration
- Easy to read graphic LCD display
- Surface anodized aluminum chamber
- Easy to clean specially coated glossy surface
- Accommodate 50mL tube with both fixed angle rotor and swing-out rotor
- Available with a variety of tube adaptors

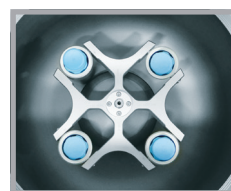
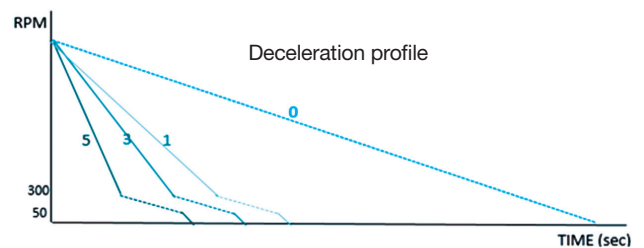

S85-4



S50-6





















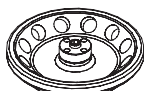























Technical Specifications

		Fleta 4 / *Fleta 40P	Fleta 4 / *Fleta 40P	
Speed RCF (xg)	Max. RPM / Fixed angle	4,000 rpm	Time control	< 100 min, pulse, continuous
	Max. RCF / Fixed angle	2,635 xg	Program memory	10
	Max. RPM / Swing-out	4,000 rpm	Noise level	< 60 dB
	Max. RCF / Swing-out	3,193 xg	Imbalance cutoff	Yes
Capacity	Max. capacity / Fixed angle	10 x 50 mL	Rotor identification	manual
	Max. capacity / Swing-out	6 x 50 mL, 12 x 15 mL conical, 4 x 85 mL	Dimension (W x D x H, mm)	448.5 x 531 x 286
ACC/DEC	ACC/DEC ramps	5/6 steps	Weight without rotor	25 kg
	Two step Deceleration	Yes	Power consumption	500 VA
	Acc. time to max. speed	35/110 sec	Power supply (V/Hz)	210~240 V, 50/60 Hz (110V optional)
	Dec. time from max. speed	38/110 sec	Cat. No.	FL-4

* Registered as medical device at MFDS¹⁾

¹⁾ MFDS : Ministry of Food and Drug Safety (KOREA)

Fixed Angle Rotors for Fleta 4

Rotor		Tube Capacity bottom Type	Required Adaptor	Bore Ø x L (mm) Radius (mm)	Max. RPM (rpm) Max. RCF (xg)
AL15-24  Hole angle : 45° Max. Capacity : 24 x 15 mL Size (ø x H) : 197 x 59 Supplied with 24 sleeves	 TR15(24) Hole dimension (Ø x L,mm) : 18 x 94.5 Hole bottom type : Flat bottom with rubber pad Max. height for tube fit (mm) :134	 8~10 mL VT/ 15mL/ 15mL conical	-	18 x 94.5 147.3	4,000 2,635
		 14 mL Round	 TR14(15f)	16.5 x 7 135.8	4,000 2,429
		 5 mL Conical	 TR5c(15f)	14 x 20 114.8	4,000 2,054
		 4~7 mLVT Round	 TR5(15f)	13.5 x 85 142.3	4,000 2,545
		 2~4 mL VT Round	 TR3(15f)	13.5 x 61 130.3	4,000 2,331
AL15-12  Hole angle : 45° Max. Capacity : 12 x 15 mL Dim. ø x H : 164.6 x 42.8 mm	 TR15(12) Hole dimension (Ø x L,mm) : 18 x 94.5 Hole bottom type : Flat bottom with rubber pad Max. height for tube fit (mm) :134	 8~10 mL VT/ 15mL/ 15mL conical	-	18 x 94.5 133.9	4,000 2,395
		 14 mL Round	 TR14(15f)	16.5 x 7 122.4	4,000 2,189
		 5 mL Conical	 TR5c(15f)	14 x 20 101.5	4,000 1,816
		 4~7 mLVT Round	 TR5(15f)	13.5 x 85 129	4,000 2,308
		 2~4 mL VT Round	 TR3(15f)	13.5 x 61 117	4,000 2,093
AL50-10  Hole angle : 45° Max. Capacity : 10 x 50 mL Rotor dimension (Ø x L, mm) : 197 x 59 Supplied with 10 sleeves	 B50c-SS 50mL Sleeve B50-SS Hole dimension (Ø x L,mm) : 30.2 x 94 Hole bottom type : Flat bottom with rubber pad Max. height for tube fit (mm) :120	 50mL Round 50mL Skirt	-	30.2 x 94 143.5	4,000 2,567
		 50mL conical	 TR50c(50f)	29.5 x 17.5 143.5	4,000 2,567
		 30mL Round	 TR30(50f)	26 x 86.5 136	4,000 2,433
		 25mL conical	 TR25c(50f)	28.8 x 14.1 116	4,000 2,075
		 15mL conical	 TR15(50f)	17.2 x 87 142.9	4,000 2,556
		 14mL Round	 TR14(50f)	17.2 x 75 142.9	4,000 2,556
AL50C-10  Hole angle : 45° Max. Capacity : 10 x 50 mL Rotor dimension (Ø x L, mm) : 197 x 59 Supplied with 10 sleeves	 B50c-SS 50mL Sleeve B50c-SS Hole dimension (Ø x L,mm) : 30.2 x 99 Hole bottom type : Conical Max. height for tube fit (mm) :121	 50mL conical	-	30.2 x 99 142	4,000 2,540
		 50mL Round	 TR50(50c)	29 x 11 138.1	4,000 2,470
		 30mL Round	 TR30(50c)	26 x 83.8 137.5	4,000 2,460
		 25mL conical	 TR25c(50c)	28.8 x 14.1 117	4,000 2,093
		 15mL conical	 TR15c(50c)	17.2 x 105 141.6	4,000 2,533

* Radius : From the center of the rotor to the inner end of tube carrier.

Swing-out Rotors for Fleta 4

S85-4

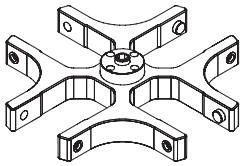

∠90°
Max. RPM : 4,000 rpm
Size (ø x H) : Ø230 x 36 mm

Bucket for S85-4



Bucket
B85

Buckets and Adaptors of S85-4

Bucket	Required Adaptor	Tube Capacity Bottom Type	Tube per Adaptor / Rotor	Bore (Ø x L, mm)	Max. height for tube fit (mm)	Max. RPM (rpm) Max. RCF (xg)
 Radius(mm): 178.5 Bucket bore (ø x L, mm) : 39 x 98 Max. height for tube fit (mm) : 149.2	-	85 mL Round	1 / 4	39 x 98	148	4,000 3,193
	TR50(85)	50 mL Round	1 / 4	29.2 x 95	143.2	4,000 3,086
	TR50c(85)	50 mL Conical	1 / 4	29.5 x 98	149.2	4,000 3,193
	TR30(85)	30 mL Round	1 / 4	26 x 85.4	144.2	4,000 3,086
	TR25c(85)	25 mL conical	1 / 4	29.5 x 62.5	123.7	4,000 2,508
	TR15(85)	15 mL Round	1 / 4	17 x 94	143.2	4,000 3,086
	TR15c(85)	15 mL Conical	1 / 4	17 x 98	149.2	4,000 3,193

* Radius : From the center of the rotor to the inner end of tube carrier.

S50-6

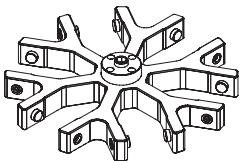

∠90°
Max. RPM : 4,000 rpm

Bucket for S50-6

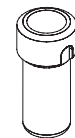

Bucket
B50



Bucket
B15c-2

Buckets and Adaptors of S50-6

Bucket	Required Adaptor	Tube Capacity Bottom Type	Tube per Adaptor / Rotor	Bore (Ø x L, mm)	Max. height for tube fit (mm)	Max. RPM (rpm) Max. RCF (xg)
 Radius : 172.8 mm Bucket bore (ø x L, mm) : 30.3 x 93.5 Max. height for tube fit (mm) : 142	-	50 mL Round 50 mL Skirt	1 / 6	30 x 93.5	132	4,000 3,091
	TR50c(50f)	50 mL Conical	1 / 6	30 x 93.5	131	
	TR25(B50)	25 mL Round	1 / 6	23 x 87	138	
	TR15(B50)	15(16) mL Round	1 / 6	18 x 87	142	
 Radius : 165.8 mm		15 mL Conical	2 / 12	17 x 86.5	138.7	4,000 2,966

* Radius : From the center of the rotor to the inner end of tube carrier.

Clinical Centrifuges

CellSpin II

Clinical Centrifuge

CellSpin II

- Ideal for cytology experiment
- Accommodate up to 0.6 mL x 12 slides
- Saves up to 30 user-defined programs
- For the concentration of small number of cells on a specific region of a slide
- SOFT start / stop function for slow acceleration and braking. Optimized for cell separation by gradient centrifugation
- Lid opens automatically at the end of the run.

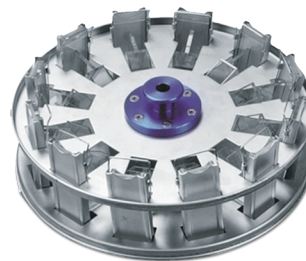

Technical Specifications

		CellSpin II*
Speed	Max. RPM / Fixed angle	3,000 rpm
RCF (xg)	Max. RCF / Fixed angle	1,175 xg
Max. capacity / Fixed angle		12 slides x 0.6 mL
ACC/DEC	ACC/DEC ramps	DEC 2 steps(Softstop)
	Acc. time to max. speed	50 / 50 sec
	Dec. time from max. speed	35 / 183 sec
Time control		< 100 min, continuous
Program memory		30
Noise level		≤ 60 dB
Imbalance cutoff		Yes
Dimension (W x D x H, mm)		318 x 436 x 260
Weight without rotor		23 kg
Power consumption		556 VA
Power supply (V/Hz)		210~240V, 50/60 Hz (110V optional)
Cat. No.		CE-II

* Registered as medical device at MFDS¹⁾

¹⁾ MFDS : Ministry of Food and Drug Safety (KOREA)

Fixed Angle Rotor for CellSpin II

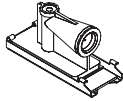
Rotor		Tube Capacity	Max. RPM (rpm) Max. RCF (xg)
<p>A-cyto-12</p>  <p>Type : Angle Rotor Max. Capacity : 12 x 0.6 mL Size (ø x H) : ø233.5 x 65 mm Radius : 116.8 mm Incl. 12 ea of cytocell set</p>	 <p>Cytocell Accessory 12 slides x 0.6 mL</p>	<p>3,000 1,175</p>	

* Radius : From the center of the rotor to the inner end of tube carrier.

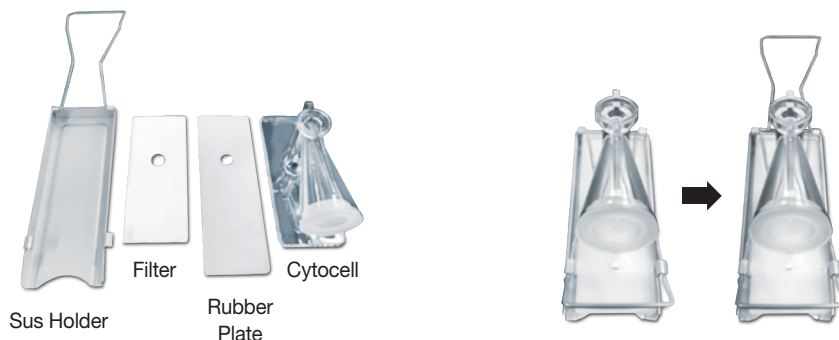

Clinical Centrifuges

SeroSpin

Clinical Centrifuge

SeroSpin

- Recommended for cross matching test in blood banks
- Specifically designed, light polycarbonate rotor
- Optional rotor with tube tightening spring
- Smooth operation with motorized lid opening and closure
- Compact, light-weighted, and ergonomic design
- Unique air cooling structure, perfect for heavily routine works
- Easy to clean specially coated glossy surface and stainless chamber



Technical Specifications

		SeroSpin*
Speed	Max. RPM / Fixed angle	3,400 rpm
RCF (xg)	Max. RCF / Fixed angle	1,118 xg
Max. capacity / Fixed angle		12 x 5mL(L 75 mm) tube
ACC/DEC	ACC/DEC ramps	5 / 6 steps
	Acc. time to max. speed	14 / 38 sec
	Dec. time from max. speed	13 / 37 sec
Time control		< 100 min, pulse, continuous
Program memory		10
Noise level		< 60 dB
Imbalance cutoff		Yes
Dimension (W x D x H, mm)		293 x 380 x 242 mm
Weight without rotor		15 kg
Power consumption		200 VA
Power supply (V/Hz)		210~240 V, 50 / 60 Hz (110 V optional)
Cat. No.		SE

* Registered as medical device at MFDS¹⁾

¹⁾ MFDS : Ministry of Food and Drug Safety (KOREA)

Fixed Angle Rotor for SeroSpin

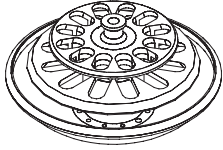
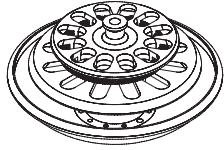
Rotor		Tube Capacity	Max. RPM (rpm) Max. RCF (xg)
A-sero-12(A) 	A-sero-12(B) Incl. a spring holder 	12 x 75 mm tube	3,400 1,118
Type : Angle Rotor Max. Capacity : 12 x 5 mL Size (ø x H) : ø173 x 87.5 mm Radius : 86.5 mm			

* Radius : From the center of the rotor to the inner end of tube carrier.

Clinical Centrifuge

HematoSpin

- Micro hematocrit centrifuge
- Perfect for hematology and buffy coat analysis
- Easy reading and calculation through the graduated bottom rotor
- Easy to use snap-fit lid lock of hematocrit rotor
- Easy to read graphical LCD display
- Smoothly working, motorized lid opening and closure
- Compact, light-weighted, and ergonomic design
- Unique air-flow structure
- Easy to clean specially coated glossy surface



Technical Specifications

		HematoSpin*
Speed RCF (xg)	Max. RPM / Fixed angle	12,000 rpm
	Max. RCF / Fixed angle	15,536 xg
Max. capacity / Fixed angle		24 x 0.07 mL capillary
ACC/DEC	ACC/DEC ramps	5 / 6 steps
	Acc. time to max. speed	35 / 59 sec
	Dec. time from max. speed	60 / 85 sec
Time control		< 100 min, pulse, continuous
Program memory		10
Noise level		< 60 dB
Imbalance cutoff		Yes
Dimension (W x D x H, mm)		293 x 380 x 242
Weight without rotor		15 kg
Power consumption		400 VA
Power supply (V/Hz)		210~240V, 50/60 Hz (110V optional)
Cat. No.		HE

* Registered as medical device at MFDS¹⁾

¹⁾ MFDS : Ministry of Food and Drug Safety (KOREA)

Hematocrit Rotor for HematoSpin

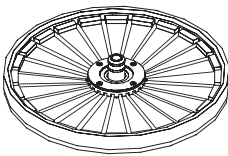
Rotor	Tube Capacity	Radius (mm)	Max. RPM (rpm) Max. RCF (xg)
<p>A-hemo-24</p>  <p>Size (Ø x H, mm): 195 x 54 Consists of lid, scale plate, and tube insert plate A capillary is not included.</p>	24 x 0.07 mL capillary	96.5	12,000 15,536



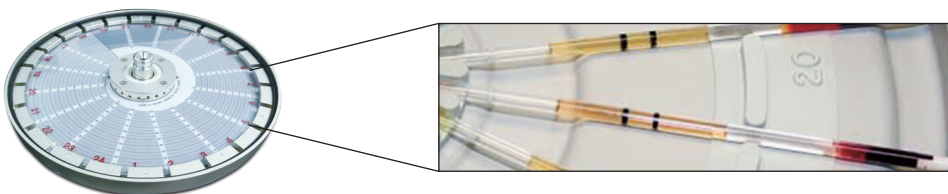























* Radius : From the center of the rotor to the inner end of tube carrier.



























Accessories

Tube Racks (Adaptors)

Adaptors of Fixed Angle Rotor

Adaptor	Bottom Type	Bore Ø x L (mm)	Compatible Tubes and Capacity	Compatible Rotors	Compatible Centrifuges
 TR0.2(2) 0.2ml tube adaptor to 2mL hole	Flat	6.3 x 21	 0.2 mL	A2.0-12 AE-2.0-24 A2.0-36 A2.0-24	M13 M15 M15R Combi 508 Combi R515 Supra R17 Supra R22 Supra R30
 TR0.5(2) 0.5ml tube adaptor to 2mL hole	Flat	8 x 37	 0.5 mL		
 TR2.0-9(250) 2mL tube adaptor to 250mL	Round	11.1 x 39	 1.5~2.0mL	A250-6	Supra R30 Supra R22 Supra R17 Supra R12 Combi R515
 TR3(15f) 3mL tube adaptor to 15mL hole	Round	13.5 x 61	1.6~5mL	AO-15/10-12 AO-15-24 A-15-24 AL15-24 AL15-12	T04 Fleta 4 T04B T05R
 TR5c(15f) 5mL tube adaptor to 15mL hole	Conical	16 x 20	 5mL conical		
 TR5(15f) 5mL tube adaptor to 15mL hole	Open	13.5x85	 4~7mL		
 TR5c-4(250) 5mL tube adaptor to 250mL hole	Conical	17.2 x 50	 5 mL conical	A250-6	Supra R30 Supra R22 Supra R17 Supra R12 Combi R515
 TR7-8(250) 7mL tube adaptor to 250mL hole	Round	13.5 x 60	 4~7 mL VT		
 TR10-7(250) 10mL tube adaptor to 250mL hole	Round	16 x 80	 8~10 mL VT		
 TR14(15f) 14mL tube adaptor to 15mL hole	Round	16.5 x 18.5	 14mL	AO-15/10-12 AO-15-24 A-15-24 AL15-24 AL15-12	T05R T04B Fleta 4
 TR14(50f) 14mL tube adaptor to 50mL hole	Open	17.2 x 75	 14mL	AL50-10 AO-50-10 A-50-10	
 TR15(50) 15mL tube adaptor to 50mL hole	Round	17 x 94	 15mL	A50-6 A50-8	Supra R30 Supra R22 Supra R17 Combi R515 Combi 508
 TR15(50f) 15mL tube adaptor to 50mL hole	open	17.2 x 87	 15mL	AO-50-10 SO-50-4 A-50-10 S-50-4 AL50-10 A-50-10	Fleta 4 T04B T05R
 TR15c(50) 15mL tube adaptor to 50mL hole	Conical	17 x 94	 15mL Conical	A50-6 A50-8	Supra R30 Supra R22 Supra R17 Combi R515 Combi 508













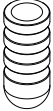

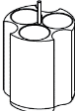















Adaptors of Fixed Angle Rotor

Adaptor	Bottom Type	Bore Ø x L (mm)	Compatible Tubes and Capacity	Compatible Rotors	Compatible Centrifuges
 <p>TR15c(50c) 15mL conical tube adaptor to 50mL hole</p>	Conical	17 x 94	 15mL Conical	A50c-6 AL50c-10 AO-50c-10 A-50c-10	Supra R30 Supra R22 Supra R17 Combi R515 Combi 508 Fleta 4 T04B T05R
 <p>TR15(85) 15mL tube adaptor to 85mL hole</p>	Round	17 x 94	 15mL	A85-6	Supra R30 Supra R22 Supra R17 Combi R515 Combi 508
 <p>TR15c(85) 15mL conical tube adaptor to 85mL hole</p>	Conical	17 x 98	 15mL	A85-6	
 <p>TR15-4(250) 15mL tube adaptor to 250mL hole</p>	Round	17.5 x 103.5	 15mL	A250-6	Supra R30 Supra R22 Supra R17 Supra R12 Combi R515
 <p>TR15c-4(250) 15mL conical tube adaptor to 250mL hole</p>	Conical	17.2 x 104.5	 15mL Conical		
 <p>TR25c(50) 25mL conical tube adaptor to 50mL hole</p>	Conical	29.4 x 47.2	 25mL Conical	A50-6 A50-8	Supra R30 Supra R22 Supra R17 Combi R515 Combi 508
 <p>TR25c(50c) 25mL conical tube adaptor to 50mL hole</p>	Conical	29.4 x 47.2	 25mL Conical	A50c-6 AL50c-10 AO-50c-10 A-50c-10	Fleta 4 T04B T05R Supra R30 Supra R22 Supra R17 Combi R515 Combi 508
 <p>TR25c(50f) 25mL conical tube adaptor to 50mL hole</p>	Conical	29.4 x 47.2	 25mL Conical	AL50-10 AO-50-10	Fleta 4 T04B
 <p>TR25c(85) 25mL conical tube adaptor to 85mL hole</p>	Conical	29.5 x 62.5	 25mL Conical	A85-6	Supra R30 Supra R22 Supra R17 Combi R515 Combi 508
 <p>TR25c(250) 25mL conical tube adaptor to 250mL hole</p>	Conical	29.5 x 61.5	 25mL Conical	A250-6	Supra R30 Supra R22 Supra R17 Supra R12 Combi R515
 <p>TR30(50) 30mL tube adaptor to 50mL hole</p>	Round	29.4 x 89	 30mL	A50-6 A50-8	Supra R30 Supra R22 Supra R17 Combi R515 Combi 508
 <p>TR30(50c) 30mL tube adaptor to 50mL hole</p>	Round	29.4 x 94	 30mL	A50c-6 AL50c-10 AO-50c-10 A-50c-10	Fleta 4 T04B T05R











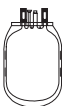
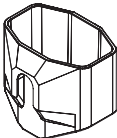













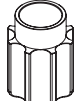

Accessories

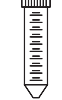
Tube Racks (Adaptors)

Adaptors of Fixed Angle Rotor

Adaptor	Bottom Type	Bore Ø x L (mm)	Compatible Tubes and Capacity	Compatible Rotors	Compatible Centrifuges
 TR30(50f) 30mL tube adaptor to 50mL hole	Round	26 x 86.5	 30mL	AL50-10 AO-50-10 A-50-10	Fleta 4 T04B T05R
 TR30(85) 30mL tube adaptor to 50mL hole	Round	38.2 x 94	 30mL	A85-6	Supra R30 Supra R22 Supra R17 Combi R515 Combi 508
 TR30-3(250) 30mL tube adaptor to 250mL hole	Round	26 x 85	 30mL	A250-6	Supra R30 Supra R22 Supra R17 Supra R12 Combi R515
 TR50(50c) 50mL tube adaptor to 50mL hole	Round	29.4 x 21.4	 50mL	A50c-6 AL50c-10 AO-50c-10 A-50c-10	Fleta 4 T04B T05R
 TR50c(50f)	Conical	29.5 x 17.5	 50mL conical	AL50-10 AO-50-10 A-50-10	Fleta 4 T04B T05R
 TR50-2(250) 50mL tube adaptor to 250mL hole	Round	29.5 x 90	 50mL	A250-6	Supra R30 Supra R22 Supra R17 Supra R12 Combi R515
 TR50c(250) 50mL conical tube adaptor to 250mL hole	Conical	29.8 x 98	 50mL conical		
 TR50sc(250) 50mL conical tube adaptor to 250mL hole	Flat	29.8 x 93	 50mL conical (Skirted)		
 TR50(85) 50mL conical tube adaptor to 85mL hole	Round	38.2 x 100	 50mL	A85-6	Supra R30 Supra R22 Supra R17 Combi R515 Combi 508
 TR50c(85) 50mL tube adaptor to 85mL hole	Conical	38.2 x 100	 50mL conical	A85-6	
 TR85(250) 85mL tube adaptor to 250mL hole	Round	38.5 x 96	 85mL	A250-6	Supra R30 Supra R22 Supra R17 Supra R12 Combi R515
 TR100(250) 100mL tube adaptor to 250mL hole	Round	44.2 x 93	 100mL		
 TR250(A500) 250mL tube adaptor to 250mL hole	Flat	69 x 136.5	 250mL	A500-6	Supra R30 Supra R22 Supra R12
 TR250(1000) 250mL tube adaptor to 1000mL hole	Flat	97.2 x 154	 250mL	A1000-4 A1000-6	
 TR500(1000) 500mL tube adaptor to 1000mL hole	Flat	97.2 x 154	 500mL	A1000-4 A1000-6	























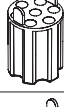



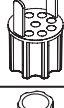

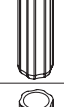
Adaptors of Swing-out Rotor

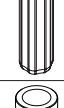
Adaptor	Bore Ø x L (mm)	Compatible Tubes and Capacity	Compatible Buckets	Compatible Rotors	Compatible Centrifuges
 TRB500-2F Adaptor for 500 mL blood bag	-	 2 x 500 mL blood bags	 B2400 Blood Bag Bucket	WS2400-6	Component R12
 TRB450-2F Adaptor for 450 mL blood bag	-	 2 x 450 mL blood bags			
 TRB250-2F Adaptor for 450 mL blood bag	-	 2 x 250 mL blood bags			
 TRB450-1 Adaptor for 450 mL blood bag	97.5 x 156	 450 mL blood bags	B1000 B1000S	WS1000-6	Component R6
 TR500(750) 500 mL tube adaptor to 750 mL bucket	75.5 x 98.7	 500mL	 B750S *cap available 750 mL Bucket B750 750 mL Bucket	WS1000-6 WS750-6 S750-4	Combi R515 Combi 508 Component wR Component R6
 TR500c(750) 500 mL conical tube adaptor to 750 mL bucket	99 x 58	 500mL			
 TR250(750) 250 mL tube adaptor to 750 mL bucket	62.3 x 87	 250mL			
 TR250c(750) 250 mL conical tube adaptor to 750 mL bucket	61.5 x 124.4	 250mL Conical			
 TR50-7N(750) 50 mL tube adaptor to 750 mL bucket	29.2 x 97	 50mL			
 TR50c-5N(750) 50 mL conical tube adaptor to 750 mL bucket	29 x 91	 50mL Conical			
 TR15-19(750) 15mL tube adaptor to 750mL bucket	17.2 x 87	 15mL			
 TR15c-14(750) 15 mL conical tube adaptor to 750 mL bucket	17 x 89	 15mL Conical			
 TR10-21(750) 10 mL tube adaptor to 750 mL bucket	16 x 87	 10mL			
 TR5-24(750) 3 or 5 mL tube adaptor to 750 mL bucket	5 mL : 13.2 x 87 3 mL : 13.2 x 60	 3or5mL			

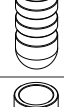

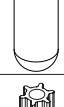























Accessories

Tube Racks (Adaptors)

Adaptors of Swing-out Rotor

Adaptor	Bore Ø x L (mm)	Compatible Tubes and Capacity	Compatible Buckets	Compatible Rotors	Compatible Centrifuges
 TR500(500) 500 mL tube adaptor to 500 mL bucket	73 x 101	 500mL	B500 (Cap included) 500 mL Bucket	S500-4	Combi R515 Combi 508
 TR250(500) 250 mL tube adaptor to 500 mL bucket	62 x 100	 250mL			
 TR100(500) 100 mL conical tube adaptor to 500 mL bucket	38.5 x 84.5	 100mL			
 TR50-4(500) 50 mL tube adaptor to 500 mL bucket	29.5 x 85.5	 50mL			
 TR50c-3(500) 50 mL conical tube adaptor to 500 mL bucket	30 x 90	 50mL Conical			
 TR15-19(500) 15mL tube adaptor to 500mL bucket	16.5 x 85	 15mL			
 TR15c-7(500) 15 mL conical tube adaptor to 500 mL bucket	17 x 95.5	 15mL Conical			
 TR10-9(500) 10 mL tube adaptor to 500 mL bucket	17 x 64	 8-10 mL			
 TR5-9(500) 5 mL tube adaptor to 500 mL bucket	13 x 64	 4-7 mL			
 TR50(85) 50 mL tube adaptor to 85 mL bucket	29.2 x 95	 50mL			
 TR50c(85) 50 mL Conical tube adaptor to 85 mL bucket	29.5 x 98	 50mL Conical			
 TR30(85) 30 mL tube adaptor to 85 mL bucket	26 x 85.4	 30mL			
 TR25c(85) 25 mL conical tube adaptor to 85 mL bucket	29.5 x 62.5	 25 mL conical			
 TR15c(85) 15 mL conical tube adaptor to 85 mL bucket*	17 x 98	 15 mL conical			













Adaptors of Swing-out Rotor

Adaptor	Bore Ø x L (mm)	Compatible Tubes and Capacity	Compatible Buckets	Compatible Rotors	Compatible Centrifuges
 TR15(85) 15 mL tube adaptor to 85 mL bucket	17 x 94	 15 mL			
 TR50c(50f) 50 mL conical tube adaptor to 50 mL bucket	30 x 93.5	 50mL Conical	B50 B50-50	S50-6 SO-50-4 S-50-4	Fleta 4 T04B T05R
 TR25(B50) 25 mL tube adaptor to 50 mL bucket	23 x 87	25mL	B50	S50-6	Fleta 4
 TR15(B50) 15 mL tube adaptor to 50 mL bucket	18 x 87	 15mL			
 TR100(100) 100mL tube adaptor to 100mL bucket	44.2 x 93	 100mL	BB100b-100	SO-100-4 S-100-4	T04B T05R
 TR85(100) 85mL tube adaptor to 100mL bucket	38.5 x 106	 85mL			
 TR50sc(100) 50mL skirt tube adaptor to 100mL bucket	29.8 x 100	 50 mL conical(Skirt)			
 TR50c(100) 50mL conical tube adaptor to 100mL bucket	30 x 103	 50mL Conical			
 TR50(100) 50mL tube adaptor to 100mL bucket	29.5 x 95.9	 50mL			
 TR30(100) 30mL tube adaptor to 100mL bucket	26 x 86	 30mL			
 TR25c(100) 25mL conical tube adaptor to 100mL bucket	29.8 x 62	 25mL Conical			
 TR15c(100) 15mL conical tube adaptor to 100mL bucket	17.2 x 108	 15mL Conical			
 TR15c-3(100) 15mL conical tube adaptor to 100mL bucket	17.2 x 108	 15mL Conical			
 TR15-3(100) 15mL tube adaptor to 100mL bucket"	17.5 x 105	 15mL			





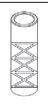







Accessories

Tube Racks (Adaptors)

Adaptors of Swing-out Rotor

Adaptor	Bore Ø x L (mm)	Compatible Tubes and Capacity	Compatible Buckets	Compatible Rotors	Compatible Centrifuges
 TR10-5(100) 10mL tube adaptor to 100mL bucket"	16.1 x 60	4~10mL	BB100b-100	SO-100-4 S-100-4	
 TR7-5(100) 7mL tube adaptor to 100mL bucket	13.5 x 60	2.6~7mL			
 TR5c-3(100) 5mL conical tube adaptor to 100mL bucket"	17.2 x 52	5mL conical			
 TR2-6(100) 2mL tube adaptor to 100mL bucket"	11.1 x 39	2mL			
 TR50(50c) 50mL tube adaptor to 50mL bucket"	29 x 11	50mL	Bd50c-100 B50c-50	SO-100-4 S-100-4 SO-50-4 S-50-4	
 TR30(50c) 30mL tube adaptor to 50mL bucket"	26 x 83.8	30mL			
 TR25c(50c) 25mL conical tube adaptor to 50mL bucket"	28.8 x 14.1	25mL Conical			
 TR15c(50c) 15mL conical tube adaptor to 50mL bucket"	17.2 x 105	15mL Conical			
 TR14(15c) 14mL tube adaptor to 15mL bucket"	16 x 7.8	14mL			
 TR5c(15c) 5mL conical tube adaptor to 15mL bucket"	16 x 20	5mL conical			
 TR14(15f) 14mL tube adaptor to 15mL bucket"	16.5 x 7	15mL			
 TR5c(15f) 5mL conical tube adaptor to 15mL bucket"	16 x 20	5mL conical			
 TR5(15f) 5mL tube adaptor to 15mL bucket"	13.5 x 85	4~7 mL VT	B15-8-100	SO-100-4 S-100-4	
 TR3(15f) 2~4mL tube adaptor to 15mL bucket"	13.5 x 61	2~4 mL VT			

Adaptors of Swing-out Rotor

Adaptor	Bore Ø x L (mm)	Compatible Tubes and Capacity	Compatible Buckets	Compatible Rotors	Compatible Centrifuges
 TR30(50f) 30mL tube adaptor to 50mL bucket"	26 x 86.5	 30mL	B50-50	SO-50-4 S-50-4	T04B T05R
 TR25c(50f) 25mL conical tube adaptor to 50mL bucket"	28.8 x 14.1	 25mL Conical			
 TR15(50f) 15mL tube adaptor to 50mL bucket"	17.2 x 87	 15mL/15mL conical			
 TR14(50f) 14mL tube adaptor to 50mL bucket"	17.2 x 75	 14mL			
 TR5(15f) 5mL tube adaptor to 15mL bucket"	13.5 x 85	 4~7 mL VT	Bd15-15		
 TR3(15f) 3mL tube adaptor to 15mL bucket"	13.5 x 61	 2~4 mL VT			

Continuous Tubular Centrifuge

J1250

- Tubular type industrial centrifuge for continuous sample separation
- Two-phase separation of liquid and solid
- Used for collecting precipitates or sludge of pharmaceutical, food processing, chemical industry or water treatment, etc.
- Good for the separation of highly viscous samples instead of filtration
- The sample flows into the bottom of the rotating bowl, the solid accumulates on the inner wall, and the liquid is discharged at the top.
- Premium quality stainless steel bowl with painted steel body or all stainless steel body
- Accurate speed control from 1,000 to 15,000 RPM through inverter and RPM Sensor
- Safety schemes of motor cut-off at door-open for spinning and distinctive emergency stop button

Provided with 3 types of input nozzles (ø 3, 4, & 5 mm)

Stainless steel trolley for handling bowl and keeping tools



Mechanical Structure

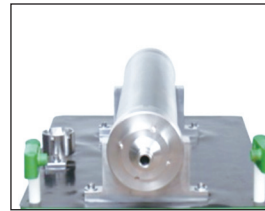
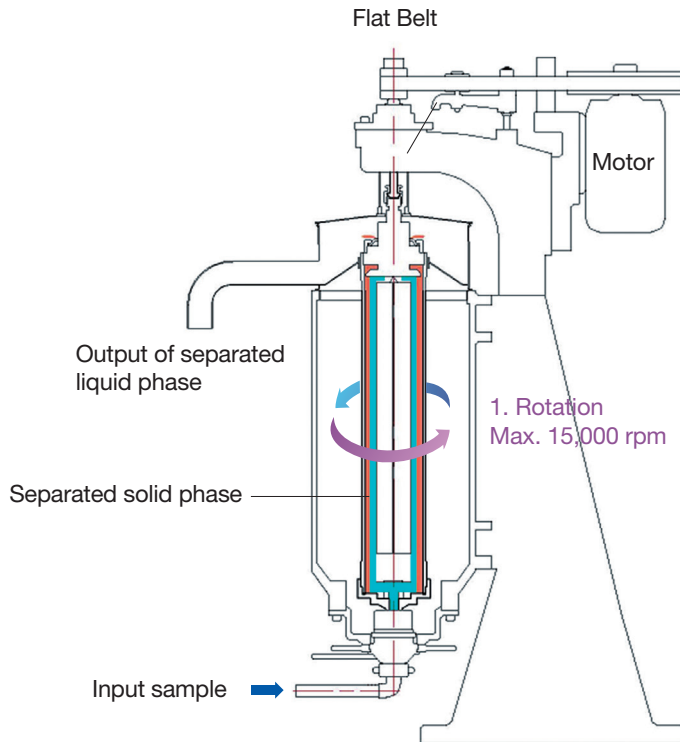

Bowl

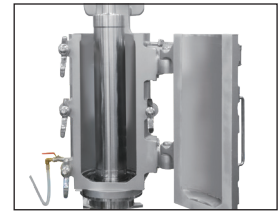

Door



Injection Pump

Peristaltic Injection Pump
or Diaphragm Pump



Controller

Applications

Pharmaceutical areas

Collection of pharmaceutical intermediates, herb extracts, plant fibers and chlorella

Food processing areas

Soy bean, fat, vegetable oil, starches, grains, gelatin, amino acids, soy sauce, reducing fat in milk

Chemistry industry areas

Cleaning and collection of ink, paints, ammonia, barium, aluminum, zinc, activated charcoal and stainings

Waste water treatment

Cleaning on straining waste water, leather waste water, petroleum tank sludge, waste oil

The other fields

Milk fat processing, cosmetics, cod-liver oil, yeast processing, and many other separation of solution and collection of solids

Industrial Centrifuges

J1250

Technical Specification_Main unit

Functions	Specification
Main unit	
Motor	
Power	380V 3.7kW (3-phase)
Tubular Bowl	
Net Capacity (L) / Weight (kg)	9 / 27
Dimension (inner/outer)	157(ϕ) x 142(ϕ) x 960(L) mm
Material	Stainless Steel 316L
Sample Collection Sheet	Teflon with a dimension of 733x395x0.4 mm
Sample Feeding pump	Peristaltic Tubing Pump (WT600-2J)
Frame and Door, Material	Powder-painted Steel (optional) Stainless steel 304 (optional) Water-jacketed
Frame Base	Powder-painted Steel H-beam with 4 wheels and 6 balancing foot
Trolley for Bowl and Tools	Stainless steel trolley with tools in a box
Dimensions (W x D x H, mm) with H-beam base without pump or trolley	860(W) x 1085(D) x 1900(H) : Door closed 860(W) x 1430(D) x 1900(H) : Door open
Net Weight with H-beam base without pump or trolley	564 kg

Technical Specification_Control unit

Functions	Specification
Control unit	
Display screen	7" wide touch (Capacitive type)
Speed control	1,000 ~ 15,000 RPM
Max. RCF	15,801 xg (Radius : 62.814 mm)
ACC / DEC ramps	3 / 4
Program memory	99
Time control	< 100 hours
Data transport	Yes (USB port)
History tracking	Yes
Inverter control	3P4W 380V, 7.5KW
Pump control	Selectable, auto or manual
Safeties	
Actual speed sensing	Yes
Door close/open sensing	Yes
Emergency Stop switch	Yes
Foot switch	Optional
Level sensor 1, 2	Optional
Dimensions (W x D x H mm)	405x 460 x 1310 (incl. warning light)
Weight without cables	47 kg

Milk-fat Centrifuge

HA400

- Specialized centrifuge for milk-fat separation
- Diverse rotors and buckets for Gerber and Babcock type tubes
- Easy to use knob control for speed and time
- Transparent lid for easy monitoring
- Any customizations available

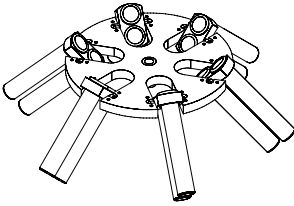
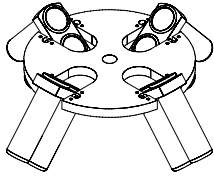
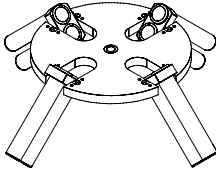

Swing-out Rotors for HA400

Rotor		Tube Capacity	Bore Ø x L (mm) Radius (mm)	Max. RPM (rpm) Max. RCF (xg)
SL100-6 (Gerber) 	SL100-4 (Gerber) 	100 mL Round	ø25 x 163 256.9	1,700 830
∠90° Max. RPM : 1,700 rpm Max. RCF : 830 xg Max. Capacity : SL100-6 (12 x 100 mL) SL100-4 (8 x 100 mL) Size (ø x H) : ø260 x 16 mm Max. height for tube fit : 215.5 mm				
SL100-4 (Babcock) 		100 ml Round	ø37 x 133.3 224.8	1,700 726
		∠90° Max. RPM : 1,700 rpm Max. RCF : 726 xg Max. Capacity : 8 x 100 mL Size (ø x H) : ø260 x 16 mm Max. height for tube fit : 179 mm		

Technical Specifications

	HA400
Speed	1,700 rpm / 830 xg
Max. Capacity	Gerber : 12 (4, 6, 8) x 100 mL Bobcock : 8 (4) x 100 mL
Timer	0~30 minutes, Free
Power supply	1 kW
Power consumption	220 V, 60 Hz
Dimension (Ø x L, mm)	670 x 420
Weight	33 kg
Cat. No.	HA-4

Sample Concentration

Centrifugal Vacuum Concentrators

HyperVAC-LITE / HyperVAC-MAX - p.74

Freeze Dryer & Cooling Trap

HyperCOOL 3055 / HyperCOOL 3110 / HyperCOOL 8080- p.82

Gas Purging Evaporation Concentrator

HyperVAP HV300 - p.88

Centrifugal Vacuum Concentrators

HyperVAC-LITE / HyperVAC-MAX

Centrifugal Vacuum Concentrators

HyperVAC™-LITE HyperVAC™-MAX





- Tabletop centrifugal concentrators with high space efficiency
- Modular configurations of centrifugal part, cold trapping and vacuum pump for versatile applications
- Available for volatile chemical solvents by accommodating with water pump, diaphragm pump or oil pump
- Accommodates a wide range of sample containers: 0.5, 2.0, 15, 50 mL tubes and microplates
- Digital reading of TIME, TEMP and VAC
- Efficient concentration of diverse samples through selectable system combination of Drip Catcher (Ice temperature) or Hyper Cool Cold trap (-55°C, -110°C)
- Teflon coated chamber and top plate

Applications

- Concentration for nucleic acids (DNA / RNA)
- Concentration for small and large volume of solvents

Technical Specifications of HyperVAC-LITE/MAX Centrifuges

		HyperVAC-LITE Centrifuge	HyperVAC-MAX Centrifuge
Max. RPM		2,000	
Max. capacity	Fixed angle	120 x 1.5/2.0 mL microtubes or 48 x 1.5/2.0 mL + 76 x 0.5 mL microtubes 32 x 10 mL	200 x 1.5/2.0 mL microtubes 24 x 30 mL
	Swing-out	2 loadings of MTP	4 loadings of MTP or DWP
Auto start / Stop of vacuum		Yes	
Chamber heating temperature Range		R.T ~ 60°C	
Vacuum pressure (mbar)		1 ~ 1,013	
Operating time		< 23 hr 59 min or continuous	
Power consumption (Centrifuge)		350 VA	700 VA
Power supply (V/Hz)		230V, 50Hz(AC220-230V, 50/60Hz; 110V optional)	
Centrifuge dimension (W x D x H, mm)		375 x 445 x 252	475 x 560 x 350
Weight (kg)		22.5 (without Rotor)	37 (without Rotor)
Cat. No.		HVC-2124 (HVC-2124-110)	HVC-2200 (HVC-2200-110)
			

Centrifugal Vacuum Concentration

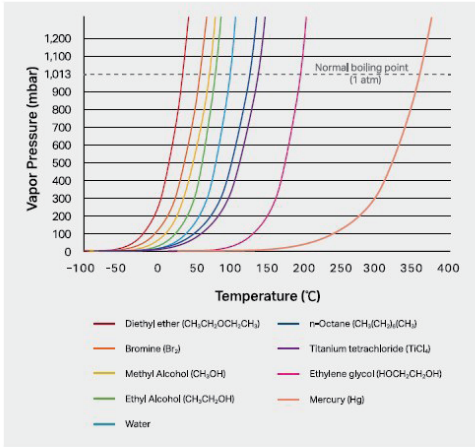

Vapor Pressure Diagram

The solvent removal is an essential process for the wide range of applications in genomics, proteomics, biochemistry, pharmaceutical study and analytical chemistry.

The energy, as heat is applied during solvent removal process, so that the liquid is evaporated to gas.

The boiling point of solvent can be decreased by applying vacuum pressure, which enables liquid vaporization at lower temperature than its boiling temperature. Also decreased boiling points and centrifugal force give benefit to minimize boiling and bumping of solvents, and prevent cross contamination and sample loss.

HyperVac generates heat up to 60°C, accommodating with vacuum pump and cold traps provides enhanced evaporation of solvent and improved sample purity.

Vapor Pressure Lowering

$$P = XP^0$$

P = Vapor pressure of the solution

X = Mole fraction of the solvent

P^0 = Vapor pressure of the pure solvent



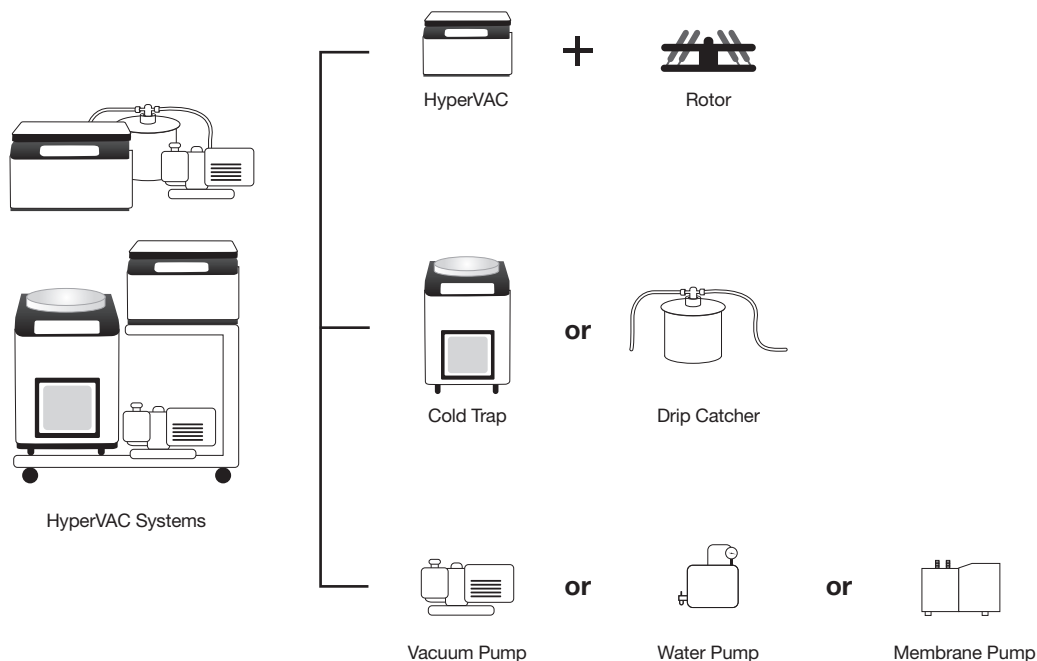







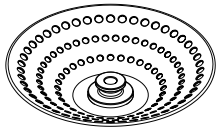



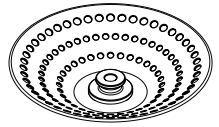



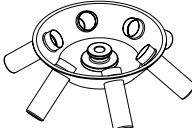
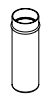









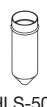

System Diagram



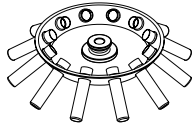



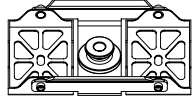



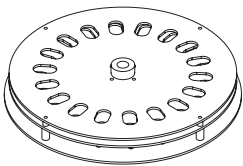

Centrifugal Vacuum Concentrators

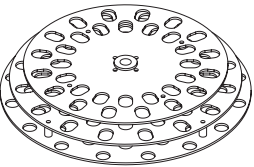
HyperVAC-LITE / HyperVAC-MAX

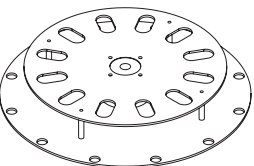
Rotors For HyperVAC-LITE (1)

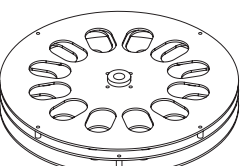
Rotor	Sleeve	Tube Capacity	Required Adaptor	Adaptor hole bottom type	Adaptor hole dimension (Ø x L mm)
HRV-m0.5/2.0-124  Capacity : 48 x 1.5 / 2.0 mL + 76 x 0.5 mL Max. RPM : 2,000 Hole angle from axis during rotation : Ø 30° Hole dimension (Ø x L,mm) : 11.1 x 2 Hole bottom type : Open Max. height for tube fit (mm) : 60 Rotor dimension (Ø x L, mm / g) : 275 x 77.5	-	 2.0mL screw cap		Open	11.1 x 2
		 1.5/2.0 mL		Open	11.1 x 2
		 0.5mL	TR0.5(2)	Open	8 x 31
		 2.0mL	TR0.5(2)	Open	6.5 x 23
HRV-m2.0-120  Capacity : 120 x 1.5 / 2.0 mL Max. RPM : 2,000 Hole angle from axis during rotation : Ø 30° Hole dimension (Ø x L,mm) : 11.1 x 2 Hole bottom type : Open Max. height for tube fit (mm) : 60 Rotor dimension (Ø x L, mm / g) : 275 x 77.5	-	 2.0mL screw cap		Open	11.1 x 2
		 1.5/2.0 mL		Open	11.1 x 2
		 1.5 mL	TR0.5(2)	Open	8 x 31
		 2.0 mL	TR0.5(2)	Open	6.5 x 23
HRV-50-6  Capacity : 6 x 50 mL Max. RPM : 2,000 Hole angle rotation : Ø 45° Hole dimension (Ø x L,mm) : 32 x 6 Max.height for tube fit (mm) : 130 Rotor dimension (Ø x L, mm) : 175.2 x 70	 HLS-50	 50 mL skirt		Flat bottom with rubber pad	30 x 99
		 50mL conical	TR50c(50f)	Conical	29.5x17.5
		 50mL	TR50(50f)	Round	29.5 x 14
		 30mL	TR30(50f)	Round	26 x 86.5
		 25mL conical	TR25c(50f)	Conical	27.1 x 14.1
		 15mL conical	TR15c(50f)	Conical	17.2 x 103
		 15 mL	TR15(50f)	Round	17.1 x 99.5
		 8~10mL VT	TR14(50f)	Round	17.1 x 83
HRV-50-6  Capacity : 6 x 50 mL Conical Max. RPM : 2,000 Hole angle rotation : Ø 45° Hole dimension (Ø x L,mm) : 32 x 6 Max.height for tube fit(mm) : 130 Rotor dimension (Ø x L, mm) : 175.2 x 70	 HLS-50c	 50mL conical		Conical	30.4 x 101
		 50mL	TR50(50c)	Round	27.9 x 11
		 30mL	TR30(50c)	Round	26x83.8
		 50mL conical	TR25c(50c)	Conical	27.1x14.1
		 15mL conical	TR15c(50c)	Conical	17 x 105
HRV-15-12  Capacity : 12 x 15 mL Max. RPM : 2,000 Hole angle rotation : Ø 45° Hole dimension (Ø x L,mm) : 20.4 x 6 Max. height for tube fit (mm) : 125(120 for conical / wider cap) Rotor dimension (Ø x L, mm) : 188.9 x 51.5	 HLS-15	 15mL conical 15mL 8~10mL VT		Flat bottom with rubber pad	18 x 87
		 5mL conical	TR5c(15f)	Conical	14 x 20
		 2~4mL VT	TR3(15f)	Round	13.5 x 61
HRV-mw-2  Capacity : 2 loadings of microplate Max. RPM : 2,000 Angle from axis during rotation : Ø 90° Max. height for tube fit (mm) : 35 Rotor dimension (W x D x L, mm) : 188 x 156.5 x 67.4		 Microplate		Flat bottom	88.5 x 130.3

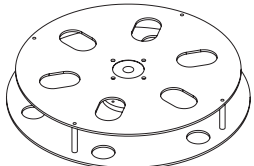









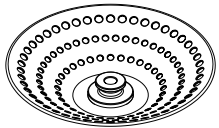





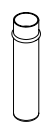

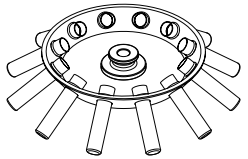







Rotors For HyperVAC-LITE (2)

Rotor	Tube/Plate Type	Max. Tube Capacity	Hole dimension (Ø x L mm)
HRV-10-18  Max. RPM : 2,000 Hole angle from axis during rotation : Ø 45° Hole bottom type : Open Max. height for tube fit (mm) : 60 Min. height for tube fit (mm) : 37 Rotor dimension (Ø x L, mm) : 241 x 51	 10 mL via	18 x 10 mL vial tube	15.5 x 25
HRV-10-32  Max. RPM : 2,000 Hole angle from axis during rotation : Ø 45° Hole bottom type : Open Max. height for tube fit (mm) : 105 Min. height for tube fit (mm) : 71 Rotor dimension (Ø x L, mm) : 280 x 51.5	 10 mL	32 x 10 mL	18 x 30
HRV-15c-12  Max. RPM : 2,000 Hole angle from axis during rotation : Ø 40° Hole bottom type : Open Max. height for tube fit (mm) : 125 Min. height for tube fit (mm) : 84 Rotor dimension (Ø x L, mm) : 280 x 51.5	 15 mL conical	12 x 15 mL conical	29 x 42.5
HRV-20-12  Max. RPM : 2,000 Hole angle from axis during rotation : Ø 45° Hole bottom type : Open Max. height for tube fit (mm) : 70 Min. height for tube fit (mm) : 40 Rotor dimension (Ø x L, mm) : 256 x 51	 20 mL via	12 x 20 mL vial tube	30 x 49.5
HRV-50c-6  Max. RPM : 2,000 Hole angle from axis during rotation : Ø 40° Hole bottom type : Open Max. height for tube fit (mm) : 125 Min. height for tube fit (mm) : 91 Rotor dimension (Ø x L, mm) : 280 x 51.5	 50mL conical	6 x 50 mL conical	30 x 49.5









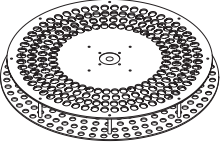

Centrifugal Vacuum Concentrators

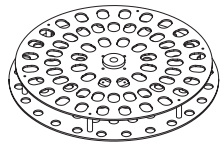
HyperVAC-LITE / HyperVAC-MAX

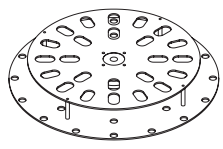
Rotors For HyperVAC-MAX (1)

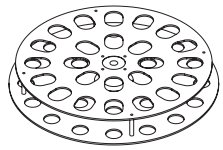
Rotor	Sleeve	Tube Capacity	Required Adaptor	Adaptor hole bottom type	Adaptor hole dimension (Ø x L mm)
HRV-m2.0-200  Capacity : 200 x 1.5 / 2.0 mL Max. RPM : 2,000 Hole angle from axis during rotation : ∠ 23.5° Hole dimension (Ø x L,mm) : 11.1 x 2 Hole bottom type : Open Max. height for tube fit (mm) : 60 Rotor dimension (Ø x L, mm) : 362 x 84	-	 2.0mL screw cap			11.1 x 2
		 1.5/2.0 mL			11.1 x 2
		 0.5mL	TR0.5(2)	Open	8 x 31
		 2.0mL	TR0.5(2)	Open	6.5 x 23
HRV-15-48  Capacity : 48 x 15 mL Max. RPM : 2,000 - Hole angle rotation : ∠ 45° - Hole dimension (Ø x L,mm) : 20.4 x 6 - Rotor dimension(Ø x L, mm) : 266 x 80	 HLS-15	 15mL conical 15mL 8~10mL VT		Flat bottom with rubber pad	18 x 87
		 5mL conical	TR5c(15f)	Conical	14 x 20
		 2~4mL VT	TR3(15f)	Round	13.5 x 61
HRV-50-12  Capacity : 6 x 50 mL Conical Max. RPM : 2,000 Hole angle rotation : ∠ 45° Hole dimension (Ø x L,mm) : 32 x 6 Max.height for tube fit(mm) : 130	 HLS-50	 50mL skirt 50mL conical		Flat bottom with rubber pad	30 x 99
		 50mL conical	TR50c(50f)	Conical	29.5 x 17.5
		 50mL	TR50(50f)	Round	29.5 x 14
		 30mL	TR30(50f)	Round	26 x 86.5
		 25mL conical	TR25c(50f)	Conical	27.1 x 14.1
		 15mL conical	TR15c(50f)	Conical	17.2 x 103
		 15mL	TR15(50f)	Round	17.1 x 99.5
		 8~10mL VT	TR14(50f)	Round	17.1 x 83
HRV-c50-12 Capacity : 6 x 50 mL Conical Max. RPM : 2,000 Hole angle rotation : ∠ 45° Hole dimension (Ø x L,mm) : 32 x 6 Max.height for tube fit(mm) : 130	 HLS-50c	 50mL conical		Conical	30.4 x 101
		 50mL	TR50(50c)	Round	27.9 x 11
		 30mL	TR30(50c)	Round	26 x 83.8
		 25mL conical	TR25c(50c)	Conical	27.1x14.1
		 15mL conical	TR15c(50c)	Conical	17 x 105
HRV-mw-4  Capacity : 4 loading of microplate Max. RPM : 2,000 Angle from axis during rotation: 90° Rotor dimension / weight(Ø x L,mm / g) : 315 x63.5 / 96.8 Max. height for tube fit (mm) : 35	 HLP-mw	 Microplate Deepwellplate		Flat bottom	88.5 x 130.3

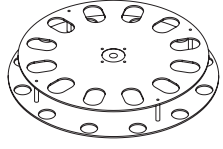
Rotors For HyperVAC-MAX (2)

Rotor	Tube/Plate Type	Max. tube capacity	"Hole dimension (Ø x L mm)"
<p>HRVP-5-192</p>  <p>Max. RPM : 2,000 Hole angle from axis during rotation : $\angle 55^\circ$ Hole bottom type : Open Max. height for tube fit (mm) : 75 Min. height for tube fit (mm) : 55 Rotor dimension (Ø x L, mm) : 365 x 51.5</p>	 <p>5mL</p>	192 x 5 mL	15.5 x 25
<p>HRVP-v8-60</p>  <p>Max. RPM : 2,000 Hole angle from axis during rotation : $\angle 50^\circ$ Hole bottom type : Open Max. height for tube fit (mm) : 70 Min. height for tube fit (mm) : 52 Rotor dimension (Ø x L, mm) : 330 x 51.5</p>	 <p>8 mL vial</p>	60 x 8 mL vial	18 x 25.5
<p>HRV-15c-24</p>  <p>Max. RPM : 2,000 Hole angle from axis during rotation : $\angle 45^\circ$ Hole bottom type : Open Max. height for tube fit (mm) : 125 Min. height for tube fit (mm) : 77 Rotor dimension (Ø x L, mm) : 336 x 51.5</p>	 <p>15 mL conical</p>	24 x 15 mL conical	18 x 27
<p>HRVP-v30-24</p>  <p>Max. RPM : 2,000 Hole angle from axis during rotation : $\angle 50^\circ$ Hole bottom type : Open Max. height for tube fit (mm) : 90 Min. height for tube fit (mm) : 61 Rotor dimension (Ø x L, mm) : 320 x 51.5</p>	 <p>30 mL vial</p>	24 x 30 mL vial	28 x 40
<p>HRVP-50c-12</p>  <p>Max. RPM : 2,000 Hole angle from axis during rotation : $\angle 45^\circ$ Hole bottom type : Open Max. height for tube fit (mm) : 125 Min. height for tube fit (mm) : 83 Rotor dimension (Ø x L, mm) : 322 x 51.5</p>	 <p>50 mL conical</p>	12 x 50 mL conical	30 x 45











Centrifugal Vacuum Concentrators

HyperVAC-LITE / HyperVAC-MAX

HyperVAC Package Information

Cat. No.	Description	Vacuum Range
<p>HHVL-AWP</p> 	<p>HyperVAC-LITE System Incl. a Drip Cather Kit a and a Water Pump HVC-2124 + HRV-m0.5/2.0-124 + HV-DC20a + HVP-VE11</p>	<p>998 mbar</p>
<p>HHVL-BDP</p> 	<p>HyperVAC-LITE System Incl. a Drip Cather Kit b and a Diaphragm Pump HVC-2124 + HRV-m0.5/2.0-124 + HV-DC20b + HVP-MP001</p>	<p>7 mbar</p>
<p>HHVM-BDP</p> 	<p>HyperVAC-MAX System Incl. a Drip Cather Kit b and a Diaphragm Pump HVC-2200 + HRV-m2.0-200 + HV-DC20b + HVP-MP001</p>	<p>7 mbar</p>
<p>HHVM-HCA</p> 	<p>HyperVAC-MAX System Incl. a HyperCOOL -55°C/4L, a HC Trap Plate, a Vacuum Hose, Rotary Vane Pump, Oil Mist Trap, All Connections & a Table A HVC-2200 + HRV-m2.0-200 + HHC-3055 + HHC-CPP-A + two HHC-VH + HVP-W2V20 + HVP-WOF150 + HVCT-MA</p>	<p>0.0013 mbar</p>
<p>HHVM-HCB</p> 	<p>HyperVAC-MAX System Incl. a HyperCOOL -110°C/4L, a HC Trap Plate, a Vacuum Hose, Rotary Vane Pump, Oil Mist Trap, All Connections & a Table B HVC-2200 + HRV-m2.0-200 + HHC-3110 + HHC-CPP + two HHC-VH + HVP-W2V20 + HVP-WOF150 + HVCT-MB</p>	<p>0.0013 mbar</p>

Ordering Information

Cat. No.		Description
HyperVAC Concentrator Main System		
HVC-2124		HyperVAC-LITE Centrifuge, Teflon coated, with Heat and Time Control incl. an Fixed Angle Rotor, HRV-m0.5/2.0-124 (220V, 50/60 Hz)
HVC-2124-110		HyperVAC-LITE Centrifuge, Teflon coated, with Heat and Time Control incl. an Fixed Angle Rotor, HRV-m0.5/2.0-124 (110V, 50/60 Hz)
HVC-2200		HyperVAC-MAX Centrifuge, Teflon coated, with Heat and Time Control incl. an Fixed Angle Rotor, HRV-m2.0-200 (220V, 50/60 Hz)
HVC-2200-110		HyperVAC-MAX Centrifuge, Teflon coated, with Heat and Time Control incl. an Fixed Angle Rotor, HRV-m2.0-200 (110V, 50/60 Hz)
Pump		
HVP-VE11		Water Pump, 18 L/min X 2, 0.0998Mpa (998 mbar)
HVP-MP001		Chemistry Diaphragm Pump MZ 2C NT (ref. VB732300) (2.3 m ³ /n, 7 mbar)
HVP-W2V20		High Vacuum Rotary Vane Pump, 0.4 kW (0.5 HP), 200 L/min, 1 x 10 ⁻³ torr (12 m ³ /n, 0,0013 mbar)
HVP-WOF150		Oil Mist Trap
Drip Catcher		
HV-DC20a		Drip Catcher Kit a, Acrylic, ø20 cm, Height 16 cm incl. 500 mL Glass Bottle and Connections to Water Pump (a 50 cm Soft Hose /10 cm Vac Hose (ø12/25 mm) with 2 clamps to connect to HyperVAC centrifuge and a Y-Shape Soft Hose to Water Pump)
HV-DC20b		Drip Catcher Kit b, Acrylic, ø20 cm, Height 16 cm incl. 500 mL Glass Bottle and Connections to Diaphragm Pump (two 50 cm Soft Hose /10 cm Vac Hose (ø12/25 mm) with 2 clamps each to connect to HyperVAC centrifuge and Diaphragm Pump)
Cooling Trap		
HHC3055		HyperCOOL -55°C Cooling Trap, 4 L, Teflon Coated, w/ Digital Display and Time Control incl. a Vacuum Hose and Clamps (220V, 50/60 Hz)
HHC3055-110		HyperCOOL -55°C Cooling Trap, 4 L, Teflon Coated, w/ Digital Display and Time Control incl. a Vacuum Hose and Clamps (110V, 50/60 Hz)
HHC3110		HyperCOOL -110°C Cooling Trap, 4 L, Teflon Coated, w/ Digital Display and Time Control incl. a Vacuum Hose and Clamps (220V, 50/60 Hz)
HHC3110-110		HyperCOOL -110°C Cooling Trap, 4 L, Teflon Coated, w/ Digital Display and Time Control incl. a Vacuum Hose and Clamps (110V, 50/60 Hz)
Table		
HVCT-MA		Table A Type for HyperVAC-MAX with HyperCOOL Underneath and a Pump Back-sided
HVCT-MB		Table B Type for HyperVAC-MAX with a Pump Underneath

Freeze Dryer & Cooling Trap

HyperCOOL 3055 / HyperCOOL 3110 / HyperCOOL 8080

Freeze Dryers & Cooling Traps

HyperCOOL™

3055 / 3110 / 8080

- Provides wide solvent coverage by dropping temperature down to -55°C, -80°C, -110°C
- HyperCOOL by itself, when equipped with manifolds or chambers, becomes a versatile freeze dryer.
- The compatible vacuum rotary vane pump generates vacuum down inside the chamber.
- Hot-gas de-ice function of chamber heating makes fast ice removal.
- Magnet embedded front cover of the condenser for very convenient cleaning
- Fully Teflon coated condenser chamber and top plate
- Basic Model : 0 ~ 760 Torr (Vacuum value below "0" is not displayed)
- Optional Pirani Sensor to display precise vacuum value below 1Torr (0.001~760 Torr).

Applications

- Study and QC of dried foods like dried fruits, meats, etc.
- Stock of bacteria, virus, fungi, etc.
- Seed preservation of plants or mushrooms
- Improved preservation of flowers and dry display study
- Pharmaceutical study and production
- Research and production of vaccine and antidote
- Tissue or cell preparation for EM analysis
- Medical research
- Archaeological finds like books, textiles, leather, etc.
- Restoration of wet documents



Freeze Drying

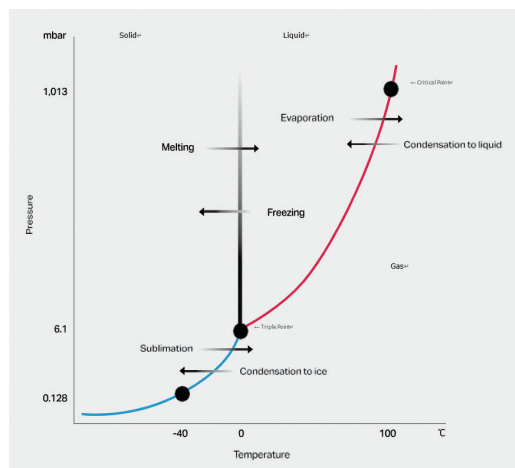

The freeze drying, also known as lyophilization is a dehydration technique through sublimation process, the shift from the solid directly into the gas without passing through liquid phase. The materials must be frozen completely to remain as solid state during sublimation process. Additionally, applying vacuum enables to lower the pressure below triple point, which to avoid the liquid phase. The freeze drying technique is used in various applications in food industry, pharmaceutical and biotechnology field and other industrial areas. HyperCOOL system allows complete removal of residual moisture.

Freezing Point Depression



$$\Delta T = iK_f m$$

ΔT = Decrease in solution freezing point

K_f = Freezing point depression constant for the solvent

m = Molality

Technical Specifications of HyperCOOL Cooling Traps

	HC3055	HC3110	HC8080
Ultimate Chamber Temp (at RT) (°C)	-55	-110	-80
Chamber Volume (L)	4		8
Trap (Chamber) Size (Ø x L)	165 x 202		305 x 355
ICE Condensing Capacity (kg)	3		8
ICE Condensing Performance (kg/day)	2.5		3
Compressor	1/2 HP	1/3 HP x 2	1 HP x 2
Refrigerant	R507	R507/R1150	R23/R507
Digital Readout	Time, Temperature		Time, Program, Temperature, Vacuum Pressure
Function	KEYLOCK, DEFROST, VACUUM, TIME		MODE, DEFROST, VACUUM, TIME
Power consumption (Resting, VA)	642	819	1500
Power supply(V/Hz)	230V, 50Hz (AC220-230V, 50/60Hz; 110V Optional)		
Dimension (W x D x H, mm)	400 x 660 x 570		710 x 610 x 960
Weight (kg)	58	72	195
Cat. No.	HHC-3055 (HHC-3055-110) 	HHC-3110 (HHC-3110-110) 	HHC-8080 (HHC-8080-110) 



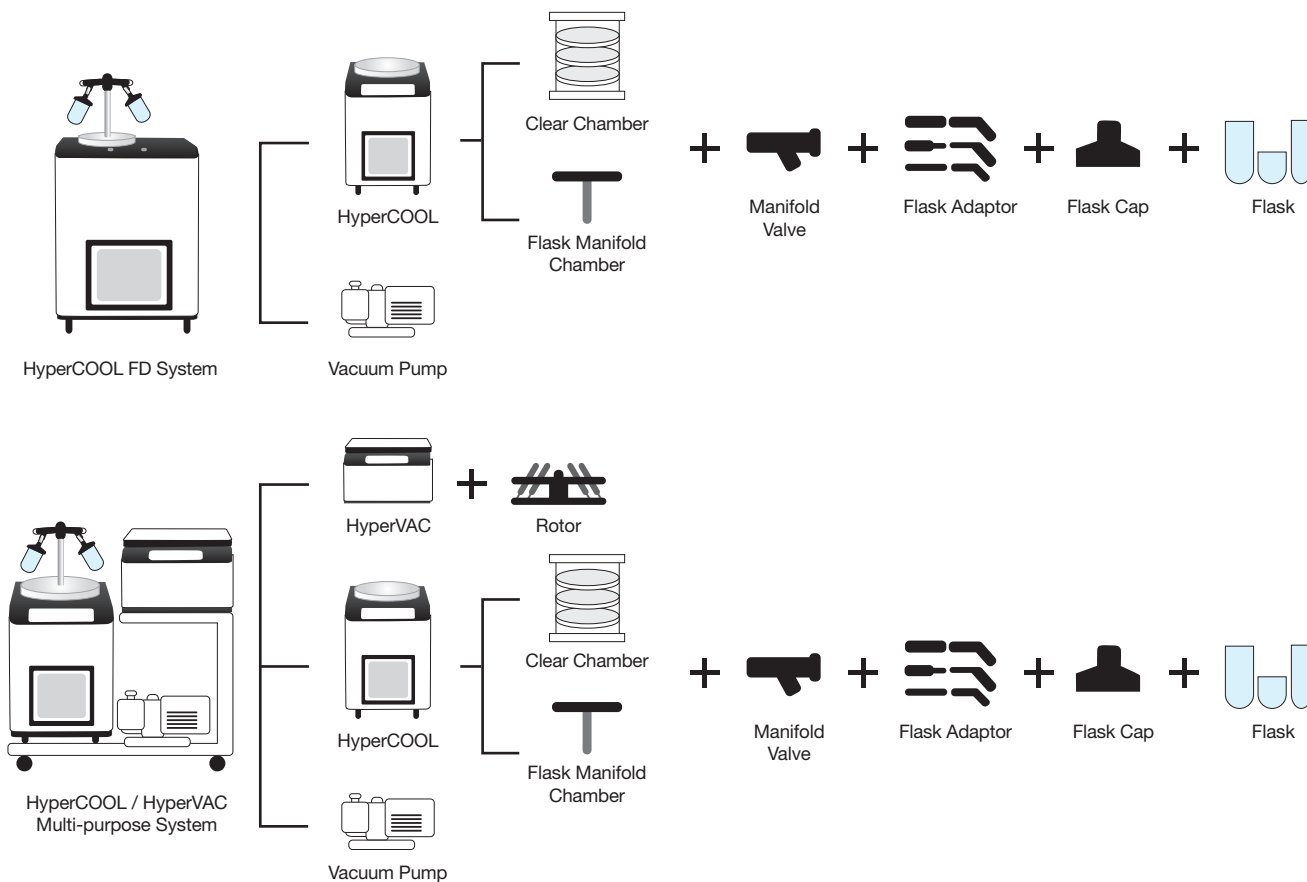



System Diagram of HyperCOOL Freeze Drying System









Freeze Dryer & Cooling Trap

HyperCOOL 3055 / HyperCOOL 3110 / HyperCOOL 8080

HyperCOOL Package Information (1)

Cat. No.		Description
<p>HHC3055-M4B HHC3110-M4B</p>		<p>Manifold Type Freeze Drying System -55°C / -110°C with 4 Valves Basic incl. a Rotary Vane Pump, Oil Mist Trap & Connections HHC-3055/HHC-3110 + HHC-CPB + HHC-MFB-4V + HHC-VH + HVP-W2V20 + HVP-WOF150</p>
<p>HHC3110-CHR</p>		<p>Chamber Type Freeze Drying System -110°C with 3 Shelves Rack incl. a Rotary Vane Pump, Oil Mist Trap & Connections HHC-3110 + HHC-CPB + HHC-CH30P + HHC-CR25 + HHC-VH + HVP-W2V20 + HVP-WOF150</p>
<p>HHC3110-CH4VR</p>		<p>Multi-Type Freeze Drying System -110°C with 3 Shelves Rack & 4 Valves Chamber incl. a Rotary Vane Pump, Oil Mist Trap & Connections HHC-3110 + HHC-CPB + HHC-CH30-4V + HHC-CR25 + HHC-VH + HVP-W2V20 + HVP-WOF150</p>
<p>HHC3110-CH8VR</p>		<p>Multi-Type Freeze Drying System -110°C with 3 Shelves Rack & 8 Valves Chamber incl. a Rotary Vane Pump, Oil Mist Trap & Connections HHC-3110 + HHC-CPB + HHC-CH30-8V + HHC-CR25 + HHC-VH + HVP-W2V20 + HVP-WOF150</p>
<p>HMHC3110-M4EC</p>		<p>Multi-Purpose, Vacuum Concentration and Freeze Drying System -110°C with 8 Valves Manifold incl. a Rotary Vane Pump, Oil Mist Trap, Connections & a Table B HVC-2200 + HVCT-MB + HHC-3110 + HHC-CPB + HHC-MFB-4V + HHC-MFE-4V + two HHC-VH + HVP-W2V20 + HVP-WOF150</p>
<p>HMHC3110-CH8VRC</p>		<p>Multi-Purpose, Vacuum Concentration and Freeze Drying System -110°C with 3 Shelves Rack & 8 Valves Chamber incl. a Rotary Vane Pump, Oil Mist Trap, Connections & a Table B HVC-2200 + HVCT-MB + HHC-3110 + HHC-CPB + HHC-CH30-8V + HHC-CR25 + two HHC-VH + HVP-W2V20 + HVP-WOF150</p>













HyperCOOL Package Information (2)

Cat. No.		Description
HHC8080-M4B		<p>Manifold Type Freeze Drying System -80°C with 4 Valves Basic incl. HHC8080 + HHC-CPB(8) + HHC-MFB-4V</p>
HHC8080-M6B		<p>Manifold Type Freeze Drying System -80°C with 6 Valves Basic incl. HHC8080 + HHC-CPB(8) + HHC-MFB-6V</p>
HHC8080-M8B		<p>Manifold Type Freeze Drying System -80°C with 8 Valves Basic incl. HHC8080 + HHC-CPM(8) + HHC-MFB-8V</p>
HHC8080-CHR		<p>Chamber Type Freeze Drying System -80°C with 3 Shelves Rack incl. HHC8080 + HHC-CPB(8) + HHC-CH30P + HHC-CR25</p>
HHC8080-CH4VR		<p>Multi-Type Freeze Drying System -80°C with 3 Shelves Rack & 4Valves Chamber incl. HHC8080 + HHC-CPB(8) + HHC-CH30-4V + HHC-CR25</p>
HHC8080-CH8VR		<p>Multi-Type Freeze Drying System -80°C with 3 Shelves Rack & 8 Valves Chamber incl. HHC8080 + HHC-CPB(8) + HHC-CH30-8V + HHC-CR25</p>





Freeze Dryer & Cooling Trap

HyperCOOL 3055 / HyperCOOL 3110 / HyperCOOL 8080

Ordering Information of HyperCOOL Accessories (1)

Cat. No.		Description
HyperCOOL Cover Plate		
HHC-CPP		HyperCOOL HC3055, HC3110 Trap Plate for Connection Vacuum Hose to Vacuum Concentrator
HHC-CPP-A		HyperCOOL HC3055, HC3110 Trap Plate for Connection Vacuum Hose to Vacuum Concentrator with Table A (GVCT-MA)
HHC-CPB		HyperCOOL HC3055, HC3110 Acrylic Base for Manifold or Chamber
HHC-CPM		HyperCOOL HC3055, HC3110 Acrylic Base for HC-MFB-8V
HHC-CPP(8)		HyperCOOL HC8080 Trap Plate for Connection Vacuum Hose to Vacuum Concentrator
HHC-CPB(8)		HyperCOOL HC8080 Acrylic Base for Manifold or Chamber
HHC-CPM(8)		HyperCOOL HC8080 Acrylic Base for HHC-MFB-8V
Manifold		
HHC-MFB-4V		4-Valve Manifold Basic with four rubber valves on a stainless steel bar, 30 cm
HHC-MFB-6V		6-Valve Manifold Basic with six rubber valves on a stainless steel bar, 30 cm
HHC-MFE-4V		4-Valve Manifold Extension with four rubber valves on a stainless steel bar, 20 cm
HHC-MFE-6V		6-Valve Manifold Extension with six rubber valves on a stainless steel bar, 20 cm
HHC-MFB-8V		8-Valve Manifold Basic with 8 rubber valves on a stainless steel bar, 30 cm

Ordering Information of HyperCOOL Accessories (2)

Cat. No.		Description
Chamber and Rack		
HHC-CH30P		Acrylic Chamber Trunk and Plain Top, ø30 cm, height 40 cm
HHC-CH30-4V		Acrylic Chamber Trunk and Top with 4 Rubber Valves, ø30 cm, height 40 cm
HHC-CR25		Stainless Steel Rack with 3 Sets of Shelves and Trays, ø25cm (Trays can be inserted up to 5)
HHC-CR-TS		A Set of a Tray and a Shelf
HHC-CH30-8V		Acrylic Chamber Trunk and Top with 8 Rubber Valves, ø30 cm, height 40 cm
Freeze Drying Glass Flask		
FD2009		Freeze Drying Glass Flask 40 mL (Ø45 mm)
FD2010		Freeze Drying Glass Flask 80 mL (Ø 45 mm)
FD2011		Freeze Drying Glass Flask 120 mL (Ø 45 mm)
FD2012		Freeze Drying Glass Flask 150 mL (Ø 45 mm)
FD2013		Freeze Drying Glass Flask 300 mL (Ø 45 mm)
FD2013-1		Freeze Drying Glass Flask 300 mL (Ø 70 mm)
FD2014		Freeze Drying Glass Flask 600 mL (Ø 70 mm)
FD2015		Freeze Drying Glass Flask 900 mL (Ø 70 mm)
FD2016		Freeze Drying Glass Flask 1,200 mL (Ø 70 mm)
FD2017		Freeze Drying Glass Flask 2,000 mL (Ø 70 mm)
Others		
FD2006		Stainless steel connector
FD2007		Rubber lid for 45 mm diameter Flask
FD2008		Rubber lid for 70 mm diameter Flask
FD1001		Vacuum Pump W2V20
FD1002		Oil Mist Trap
HHC-AA		Acetal Adaptor for the connection Vacuum Hose to Rubber Valve
HHC-VH		Vacuum Hose with 2 clamps, 100 cm



Gas Purging Evaporation Concentrator

HyperVAP HV300

Gas Purging Evaporation Concentrator

HyperVAP™

- Accelerated evaporation performance by gas purging mechanism
- Proprietary semi-helical gas flow mechanism to achieve the highest evaporation rate
- Diverse dimensions of nozzles and tube racks can be tailored upon customer needs.
- Four independent timer settings for different solvents
- Dual-step control of gas pressure and time to prevent “bumping” of the sample on startup
- Differentiated monitoring functions: 3-side transparent glass panels, blue backlight (on/off switchable) and traffic lights

Optimized for evaporating organic solvents including sample preparations for chromatography Safety features: tempered glass panels, automatic gas shutoff function, traffic lights (fan, door, heater)



Maximized Evaporation by Semi-helical Air Flow (Patented)

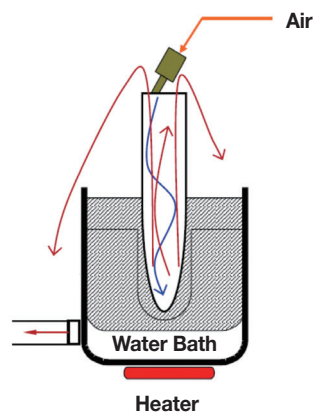
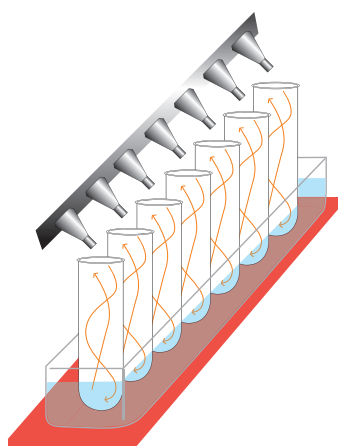

Reference Data

Solvent \ Pressure	40 psi	30 psi	20 psi
Hexane	1:50	2:10	3:20
Methanol	5:10	6:30	9:50
Acetonitrile	5:45	7:10	11:40
Ethanol	6:10	8:30	15:30

(min:sec)

Experimental Conditions

- Sample volume : 5 mL in 20 mL tube
- Temperature : 40°C
- Gas : nitrogen gas

Applications

- Pharmaceutical biotech compounds
- Clinical samples
- Environmental samples
- Forensic and crime samples
- Agrochemical samples
- Food and beverage analysis

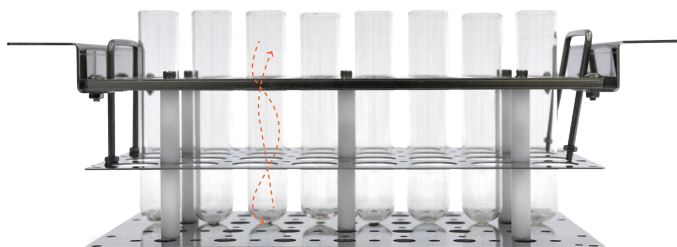

Gas Purging Evaporation Concentrator

HyperVAP HV300

Standard Nozzles & Racks

- 4 x 8 nozzle & a tube rack for 24 x 120 mm tubes
- 3 x 6 nozzle & a tube rack for 30 x 120 mm tubes
- 3 x 5 nozzle & a tube rack for 38 x 140 mm tubes
- 2 x 3 nozzle & a tube rack for 72 x 140 mm tubes
- Customized nozzle assembly and tube rack and optionally available

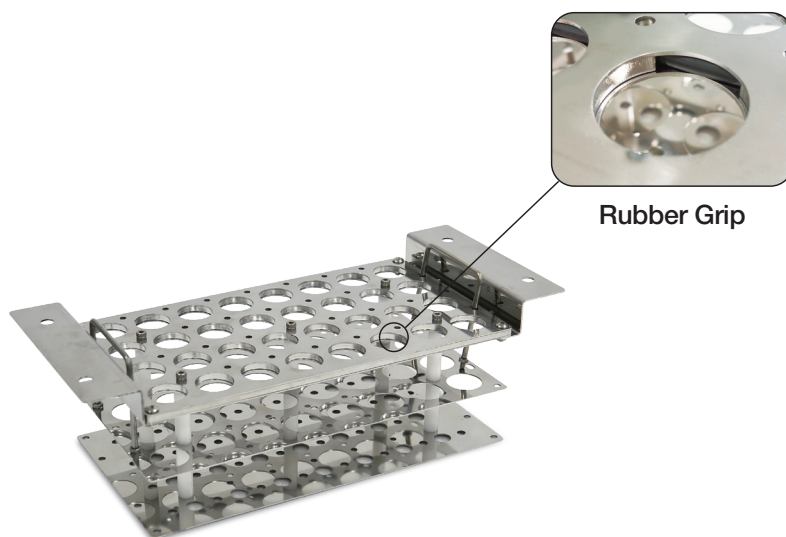
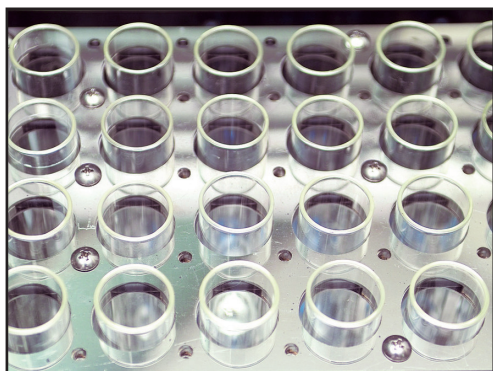

Technical Specifications

		HyperVAP
Sample Capacity	Number of Samples	6~32
	Sample Volume (mL)	5~300
Gas		Compressed air, N ₂ , etc.
Pressure	Operation Gas Pressure (psi)	15~50
	Pressure Control	Automated dual-step control (initial & operating pressure)
Max. Time for Initial Pressure (min)		~ 99
Max. Time Control (min)		~ 999 (4 independent channels)
Water Bath Temperature (°C)		~ 99
Forced Vapor Evacuation		Yes (by fan)
Power consumption		800 VA
Power supply (V/Hz)		230V, 50 Hz (AC220-230V, 50/60 Hz; 110V Optional)
Dimension (W x D x H, mm)		590 x 340 x 320
Weight (kg)		26.5

Ordering Information

Cat. No.	Description
HV-300 concentrator consists of a complete system installed with a nozzle assembly and a tube rack, incl. nozzle caps.	
HGP-300-48	HV300 with 4 x 8 nozzles assembly and a choice of a tube rack
HGP-300-36	HV300 with 3 x 6 nozzles assembly and a choice of a tube rack
HGP-300-35	HV300 with 3 x 5 nozzles assembly and a choice of a tube rack
HGP-300-23	HV300 with 2 x 3 nozzles assembly and a choice of a tube rack
Nozzle	
HGP-N48	Nozzle assembly, 4 x 8 (32 positions)
HGP-N36	Nozzle assembly, 3 x 6 (18 positions)
HGP-N35	Nozzle assembly, 3 x 5 (15 position)
HGP-N23	Nozzle assembly, 2 x 3 (6 position)
HGP-NC	Nozzle caps, 8/pk
Tube Rack	
HGP-R48-24	Tube rack for 24 mm x 120 mm (Ø x L) tubes (4 x 8 positions)
HGP-R48-16	Tube rack for 16 mm x 100 mm (Ø x L) tubes (4 x 8 positions)
HGP-R48-15	Tube rack for 15 mm x 70 mm (Ø x L) tubes (4 x 8 positions)
HGP-R36-30	Tube rack for 30 mm x 120 mm (Ø x L) tubes (3 x 6 positions)
HGP-R35-38	Tube rack for 38 mm x 140 mm (Ø x L) tubes (3 x 5 positions)
HGP-R23-72	Tube rack for 72 mm x 140 mm (Ø x L) tubes (2 x 3 positions)

Sample Growing

Laboratory Fermentors

G-FL - p.94

Photo Bioreactors

PBR - p.98

CO₂ Incubator

ARAP150 / ARAP170 - p.100

Laboratory Fermentors

G-FL

Laboratory Fermentors

G-FL

- Optimized for high density microbial growth
- Intuitive control with 8" Android Tablet
- All-in-one program allows precise control of all sensors and motors directly from controller
- Compact design enables various culture experiments even in a small laboratory
- Wide ranges of vessels of single, double or bowl types from 1.5 L to 14 L
- Individually controlled four peristaltic pumps for pH, DO, anti-foam and feeding
- Accurate PID temperature control



Applications

- Microbial fermentation
- Cell cultivation
- Production of biomass
- Extracellular metabolites
- Intracellular components

Main Control Screen

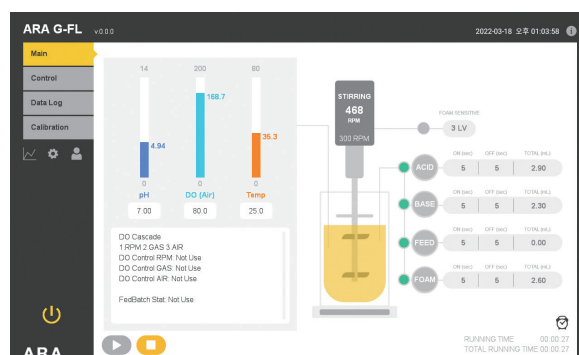

Structure of Laboratory Fermentor, LiFlus GX

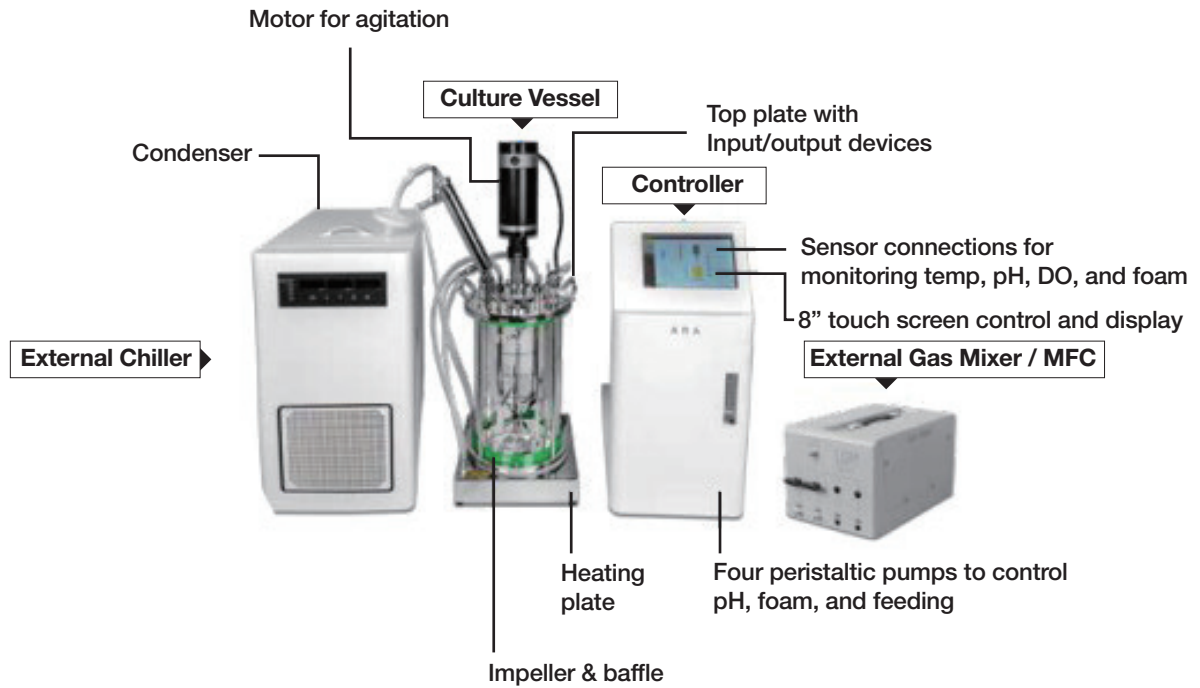

Availability of Vessel Types and Sizes

Vessel Type	1.5L	3L	5L	7L	10L	14L
Working Volume	1	2	3	5	7	
Single	●	●	●	●	●	
Single round		●	●	●		
Double		●	●	●		
Bowl					●	●

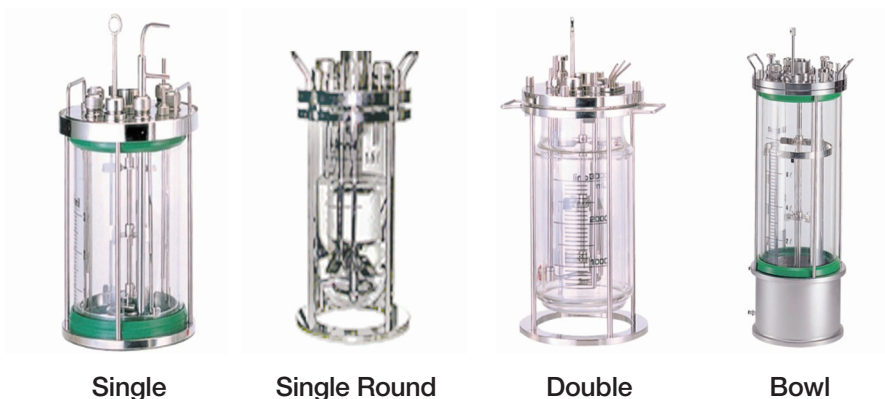

Single

Single Round

Double

Bowl

Laboratory Fermentors

G-FL

Basic Diagram of Culture Vessel and Variations

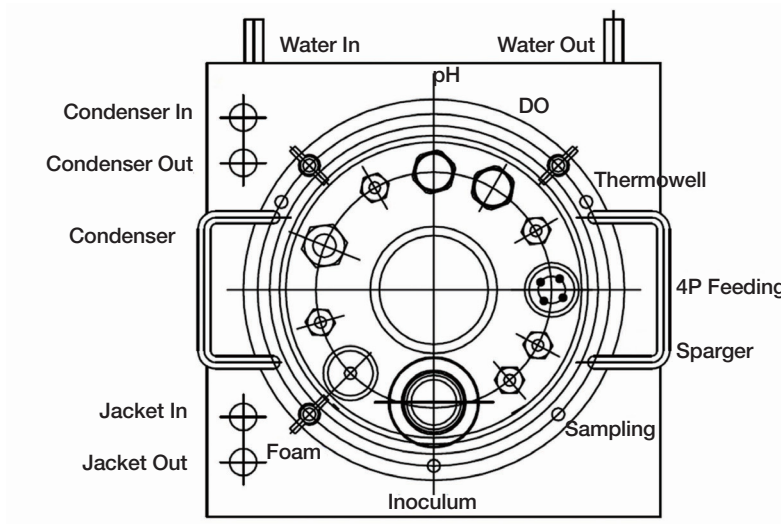

- Ports on the top plate can be composed by the necessities of controls and inputs /outputs.

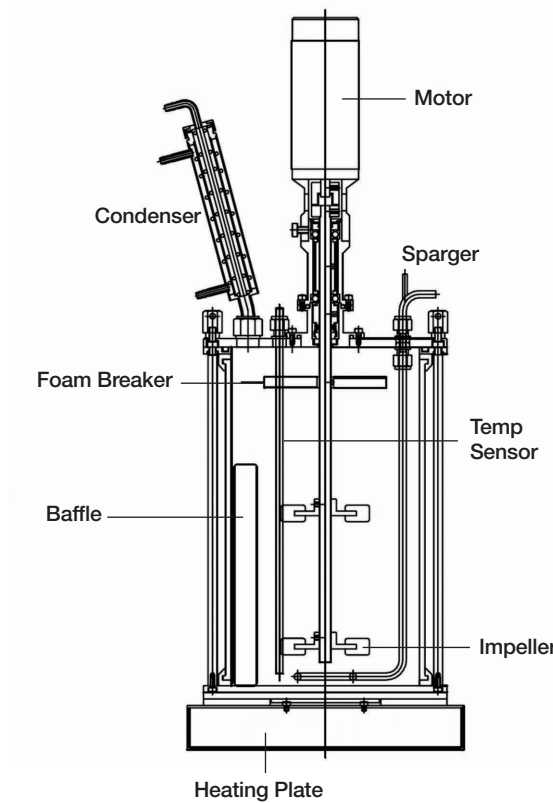

- A motor power and condenser size need to be selected by the vessel size.
- Sparger type and the size of foam breaker should be selected by growing sample's requirements.
- Heating method can be selected between direct heating plate, heating blanket, or double vessel.

Technical Specifications

		G-FL
Controller	Display	8" Android Tablet
	Feeding Pumps	Max. 4 (14 rpm)
	Dimension (W x D x H, mm)	245 x 487.5 x 555
	Weight	16.2 kg
Agitation	RPM range	60 ~ 1,500 rpm
	Motor	DC motor
Temp. Control Range (sensor)		8 ~ 70 °C
pH Control Range (sensor)		2 ~ 12
DO Control Range (sensor)		0 ~ 200 %
Anti Foam Sensing		Conductivity type
Micro Sparger pore size		20 μ m
ORP Control Range (sensor)		\pm 2,000 mV
MFC / MFM		RS485 system
Data Log (Direct Save)		csv file, auto log save (10 - 3,600 sec)
Analog Output / Input		Max. 4 Channel / Max. 8 Channel

- Impeller type should be chosen by the characteristics of growing sample from Rushton turbine, pitched blade, or marine-blade, or varied impeller.



Rushton
Turbine Impeller



Pitched
Paddle Impeller

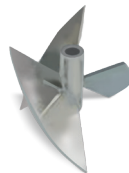

Marine Impeller

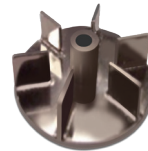

Varied Impeller

Photo Bioreactors

PBR - Lab Scale / Pilot Scale

Photo Bioreactors

PBR

Lab Scale / Pilot Scale

- Photosynthetic microorganism cultivation
- Various types of photo bioreactor (flat, α -type, pipe and etc.)
- LED illumination with full spectrum imitates natural sunlight by emitting light at 430 nm, 630 nm, white LED
- Easy to scale up
- No standard models
- Easy and costly customization according to individual application



Vessel Type Photo Bioreactor,
Illuminated with Inner LED Bars



Pilot Scale, Plate Type Photo Bioreactor,
Illuminated by Internal LED Plate

Applications

- Phototrophic microorganism cultivation
- Production of phototrophic microalgae biomass

Technical Specifications

		PBR Lab Scale
Agitation	Drive	Top drive motor (mechanical drive)
	Range	100~1,200 rpm
	Impeller	2-Rushton turbine impeller
Temperature	Range & Sensor	Ambient + 3~80°C RTP (Pt-100), PID control
Aeration	Sparger & Gas mode	Ring sparger (round type), Air-flow meter (standard) or 2 gas and 4 gas mixer (option)
Exhaust system	Filter & Condenser	0.2°C air filter cartridge, SUS 316
pH	Range	2.0~12.0 pH of set point, PID control
	Electrode	Gel type
DO	Range	0~200%, PID control
	Electrode	Polarographic type
Anti-foam	Electrode	Conductivity type
Peristaltic Pumps	Control	4 constant speed pumps each assignable to a wide variety of function for control of acid, base, foam and feed
Recording	pH, DO, Temp, Foam, Agitation, Peristaltic pump, etc.	
Power supply (V/Hz)	220V, 60Hz	

		PBR Pilot Scale
Total volume illuminated	20~100 L	
Sterilization autoclave	Possible	
Photosynthetic module	Plate	
Illumination unit	White LED	
Illumination	On / Off control	
Air flow rate	5~20 L/min	
pH-control	CO ₂ Gas	
Temperature	Measurement & control	
Optical density	Turbidity sensor	
Power supply (V/Hz)	220V, 60Hz	



Vessel Type Photo Bioreactor,
Illuminated by External Octagon LED Panels



Pilot Scale, Plate Type Photo Bioreactor,
Illuminated by External LED Plates

CO₂ Incubator

P150 / P170

CO₂ Incubator

ARA P150 / P170

- Direct heating, air jacketed CO₂ incubator
- Internal max. capacity 150L/170 L
- No fan, no vibration, no maintenance of HEPA filter, no spread-out of contamination
- Maximized inner space by no fan structure
- Dual beam NDIR CO₂ sensor
- Intuitive 7" control screen and informative display
- Easy-to-clean stainless steel chamber
- Stackable CO₂ Incubator
- Supplied with three perforated stainless steel shelves
- 120°C sterilization (P170 only)
- Reversible exterior door open (right / left) (P170 only)



Applications

- Mammalian cell and tissue cultivation



USB port for data transfer

CO₂ Incubator

P150 / P170

Technical Specifications

	P150	P170
Inner capacity	150 L	170 L
Door left/right	Factory Installed	On site
Fan	No	No
Decontamination	-	120°C Dry
External dimension (mm)	657W x 741D x 877H	720W x 639D x 908H
Internal dimension (mm)	470W x 520D x 610H	547W x 479D x 647H
Power requirements	220V, 60Hz	
Net weight	62 kg	91 kg

Display
7" LCD touch screen

Date Tracking
240 hours continuous

Temperature
- Microprocessor PID
Control system
- Range : Amb. +5 ~ 50°C
- Accuracy : ±0.2°C
- Uniformity : ±0.3°C
- Recovery time
: less than 10 min

rH system
- Humidity method
: Water pan
- Humidity range, %RH
: over 90%

CO₂ control
- Microprocessor PID
Control system
- Sensor : NDIR
- Control range : 0 ~ 20%
- Control accuracy : ±0.1
- Recovery rate : less than 7 min



Touchscreen with graphic display



3 shelves divided door

Ordering Information

Cat. No.	Product
APL150	ARA P150 CO ₂ Incubator with Single Glass Door, Left-Open
APR150	ARA P150 CO ₂ Incubator with Single Glass Door, Right-Open
APL170	ARA P170 Incubator with Single Glass Door, Left-Open
APR170	ARA P170 Incubator with Single Glass Door, Right-Open
APA-SPS	Shelf with 2 Supports, perforated, SS
APA-CGS	CO ₂ gas pressure regulator



Sample Storage

Deep Freezers

Upright Type, ARA M/MD Series - p.106

Accessories - p.111

Deep Freezers

Upright Type - ARA M/MD Series

Upright Type Deep Freezers

ARA M/MD Series

- Fast pull-down and recovery to optimal storage temperature (500L Dual / -95°C, 700 L Dual / -90°C)
- Unique pin-less Block Condenser and Independent Compressor (single or dual selectable) structures
- Failure free Dual Brain PCB and dual Independent Compressor systems
- Effortless Auto-Door with safe lock& unlock function (optional manual door is available)
- Controllable ECO mode of dual compressor model for energy saving operation
- Informative 7" display and touch screen control
- Data tracking and storage to chart recorder or through USB transfer
- Alarm warning of text message transfer to max. 5 users
- No need of dust cleaning by very simple compressor and condenser structure
- LCO2 or LN2 backup system is available

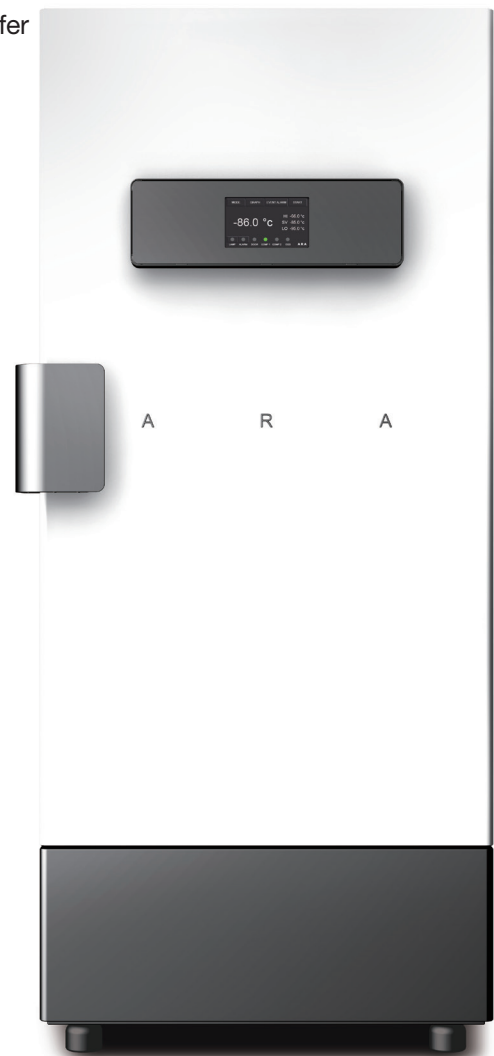

Deep Freezers

Upright Type - ARA M/MD Series

Technical Specifications

	Upright Type Deep Freezer
Capacity	85, 317, 404, 514, 732, 876 Lit.
Temperature range	-86°C/-80°C ~ -65°C/-60°C or -95°C/-90°C ~ -65°C/-60°C
Compressor	Hermetic Type, Single or Independent Dual Compressor (Eco mode of Dual type for economic operation)
Condenser Type	Block Condenser, No pin, Filter Free Mechanism
Refrigerant	Natural (CFC Free Refrigerant System)
Controller & Display	Failure free Dual Controller and 7" Touch Screen TFT LCD
Door	Door opening and closing by pressing a touch button on control screen (Manual Door is Optional)
Material	Internal Stainless Steel / External Powder Coated Steel Plate
Power supply	Single Phase, AC 230V, 50/60Hz (Optional AC 120V, 60Hz)



Robust and Flexible Design of Door Handle

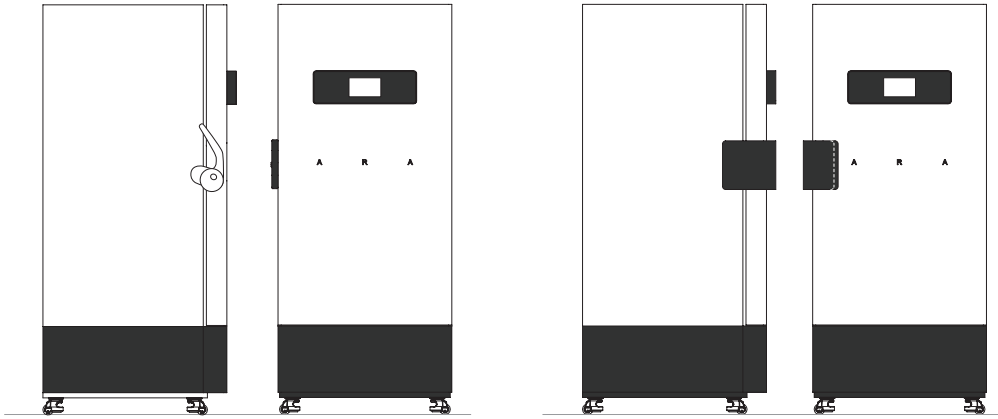

Manual Door

Automatic Door

Independent Dual Compressor System

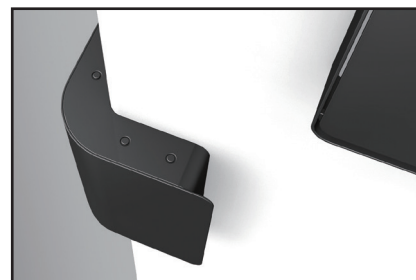
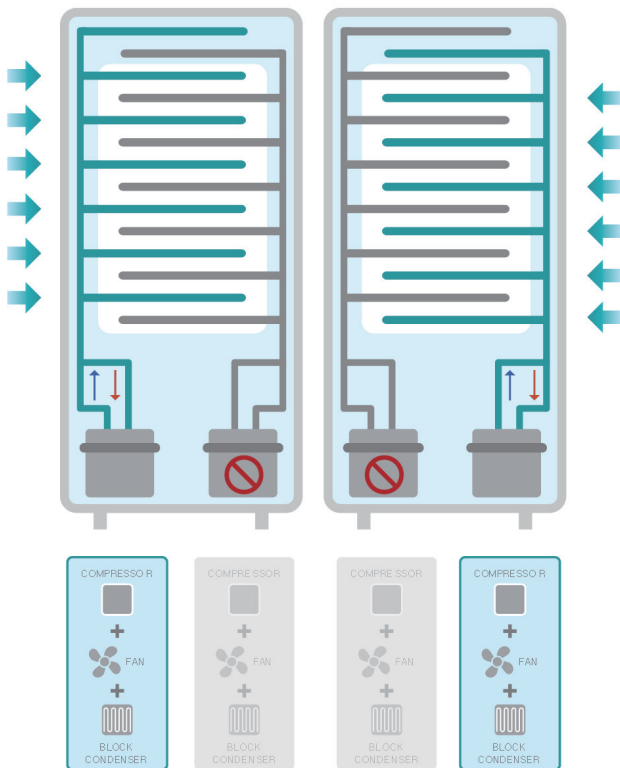

SMART Freezing System with Block Condenser

ARA M Deep freezers advanced functionality with intuitive display and control panel

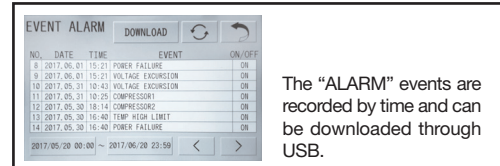
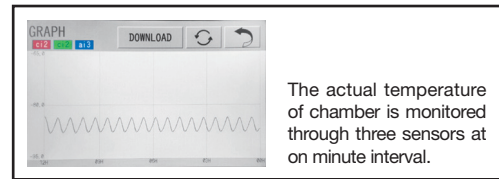
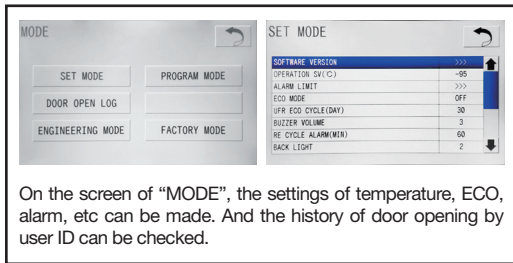

This optional function of LCO₂ back can be used by manually or activated under the freezing system error condition.

The color of "ALARM" turns to RED at the situations of abnormal temperature and compressor, door open status, improper voltage, battery shortage, power failure, etc.

The opening of the door is simply accomplished by one touch click of the "DOOR" button followed by ID and password input. The ID can be managed up to 100.

The USB port for downloading temperature graph, maximum for 300 days and ALRAM event history.

ARA M Deep Freezers scheme shortens the pull-down time of ultra-low temperature.

Model	ARA MD300	ARA MD500	ARA MD700	ARA MD870
Time to -80°C	120 min	180 min	210 min	170 min
Time to -90°C	180 min	280 min	380 min	260 min
Time to -95°C	220 min	330 min	-	-

Ordering Information

		ARA M80	ARA M300	ARA MD300	ARA M400	ARA MD400	ARA M500	ARA MD500
Capacity		85 Lit.	317 Lit.		404 Lit.		514 Lit.	
Temperature Range		-86°C ~ -65°C	-86°C ~ -65°C	-95°C ~ -65°C	-86°C ~ -65°C	-95°C ~ -65°C	-86°C ~ -65°C	-95°C ~ -65°C
Compressor		Single	Single	Dual, Independent	Single	Dual, Independent	Single	Dual, Independent
Rack Capacity		2 x 2 tray for freezer box	3 x 4 tray for freezer box		4 x 4 tray for freezer box			
Chamber Dimension (W x D x H, mm)	Internal	340 x 485 x 520	470 x 515 x 1,310		600 x 515 x 1,310		600 x 655 x 1,310	
	External	572 x 830 x 1,147	800 x 892 x 1,990		930 x 892 x 1,990		930 x 1,032 x 1,990	
Net Weight		102 kg	190 kg	220 kg	220 kg	260 kg	245 kg	284 kg
Power consumption	Eco Mode	321 W/h	364 W/h	364 W/h	386 W/h	386 W/h	469 W/h	469 W/h
	Dual Mode			415 W/h		461 W/h		526 W/h
Cat. No.	Auto Door	-	AMUS300	AMUD300	AMUS400	AMUD400	AMUS500	AMUD500
	Manual Door	AMUS080-M	AMUS300-M	AMUD300-M	AMUS400-M	AMUD400-M	AMUS500-M	AMUD500-M

		ARA M700	ARA MD700	ARA M870	ARA MD870
Capacity		732 Lit.		876 Lit.	
Temperature Range		-80°C ~ -65°C	-90°C ~ -65°C	-80°C ~ -60°C	-90°C ~ -60°C
Compressor		Single	Dual, Independent	Single	Dual, Independent
Rack Capacity		6 x 4 tray for freezer box			
Chamber Dimension (W x D x H, mm)	Internal	880 x 635 x 1,310		880 x 760 x 1,310	
	External	1,210 x 1,012 x 1,990		1,210 x 1,137 x 1,990	
Net Weight		285 kg	327 kg	335 kg	385 kg
Power consumption	Eco Mode	508 W/h	508 W/h	547 W/h	547 W/h
	Dual Mode		576 W/h		613 W/h
Cat. No.	Auto Door	AMUS700	AMUD700	AMUS870	AMUD870
	Manual Door	AMUS700-M	AMUD700-M	AMUS870-M	AMUD870-M



Rack System for Freezer

Stainless Steel Rack for Upright Type Freezer

Rack Type	Small Size Rack			Medium Size Rack			Large Size Rack			X-Large Size Rack		
	Open Rack	Tray Drawer	Box Drawer	Open Rack	Tray Drawer	Box Drawer	Open Rack	Tray Drawer	Box Drawer	Open Rack	Tray Drawer	Box Drawer
Dimension (W x D x H, mm)	140 x 430 x 220		140 x 410 x 220	140 x 430 x 290		140 x 425 x 290	140 x 570 x 290			140 x 710 x 290		
Applicable Freezer	ARA M80			ARA M(D)300/400			ARA M(D)500/700			ARA M(D)870		
Quantity of Available Boxes	12 ea (3 x 4)			15 ea (3 x 5)		12 ea (3 x 4)	20 ea (4 x 5)		16 ea (4 x 4)	25 ea (5 x 5)		
Material	Stainless Steel											
Cat. No.	AMA-ORS	AMA-TDS	AMA-BDS	AMA-ORM	AMA-TDM	AMA-BDM	AMA-ORL	AMA-TDL	AMA-BDL	AMA-ORX	AMA-TDX	AMA-BDX

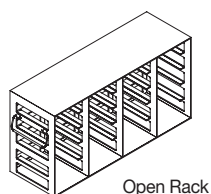

Open Rack

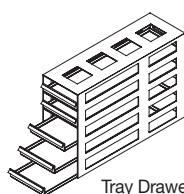

Tray Drawer

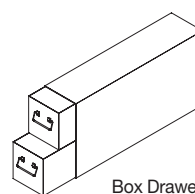

Box Drawer

Freezer Box

Cat. No.	Description
AMA-B001	Freezer box, Paper with dividers for 9 x 9 holes, 127 (W) x 127 (D) x 52 (H) mm
AMA-B002	Freezer box, PP with dividers for 9 x 9 holes, 127 (W) x 127 (D) x 52 (H) mm



Optional Common Accessories

Temperature Chart Recorder

- Continuously monitor and record freezer temperature
- Easy to check the operation of the equipment
- 1 chart records 7days (included 60 charts)
- Recorder records temperatures from -100°C to 0°C
- Min/Max Temperature can be checked on digital display

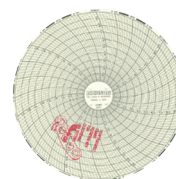

Remote Alarm System

- Remote warnings for overtemperature (above -65°C)
- Alarm system is connected to the regulator and activates when the temperature rises
- Alarm is sent via phone or text
- Multiple phone numbers can be registered to receive alarm at the same time



LCO₂ Backup System (LCO₂ Gas Tank is optional)

- Protect samples of the freezer in case of power failure
- Liquid Carbon Dioxide(freezing point is -78°C) is injected into the chamber to keep the internal temperature below -65°C
- The operating time depends on the gas tank capacity.



Ordering Information

Cat. No.	Description
AMA-TR622	Temperature Chart Recorder
AMA-CP657	Chart Paper, 60 Charts per one box for 420 days recording in AMA-TR622
AMA-P222	Chart Recorder Replacement Pens, 6ea Red color, for AMA-TR622
AMA-RAS	Remote Wire/Wireless Alarm System
AMA-LCO	LCO ₂ Backup System

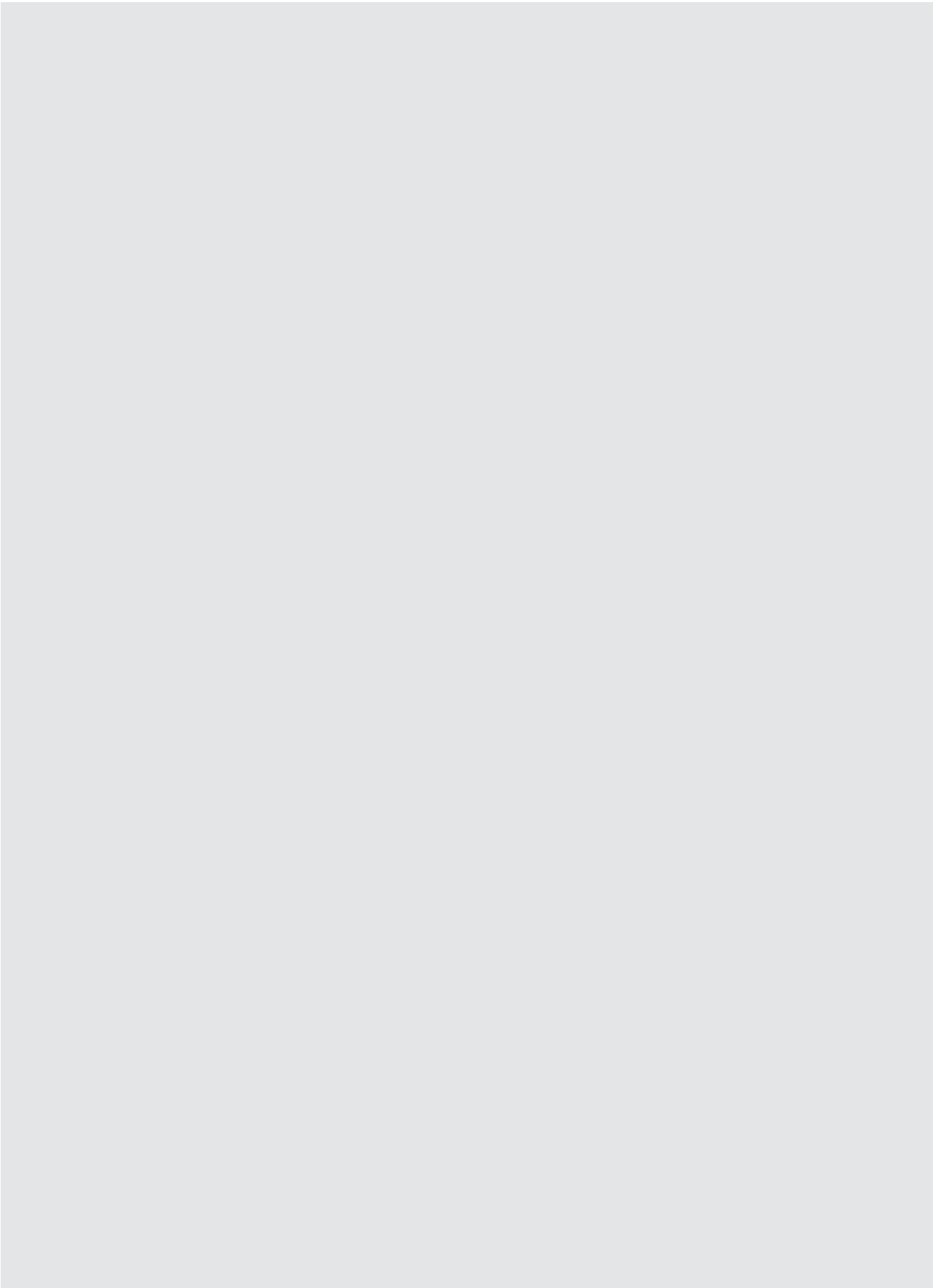

hanil

Hanil Scientific Inc.

16 Arayukro, Gimpo 10136, Rep. of KOREA
T. 02-3452-8965 | T. +82-2-3472-0727 (Int'l)
info@ihanil.com | techsupport@ihanil.com
www.ihanil.com